

RZ06S 42-2048

iC-RZ4248 Encoder Disc and Code Description



Rev A4, Page 1/2

ORDERING INFORMATION

Type	Order Designation	Description/Options
Encoder Disc	RZ06S 42-2048	Code Disc 2048 PPR, dia 42.5 mm

PHYSICAL DIMENSIONS

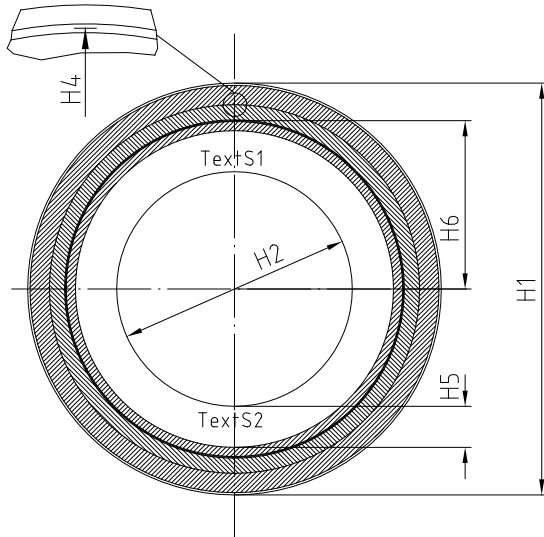

Item	Parameter	[mm]	Tolerance
H1	Outer Diameter	42.5	$\pm 100 \mu\text{m}$
H2	Inner Diameter	18.0	$+ 200 \mu\text{m}$
H3	Thickness	1.0	$\pm 100 \mu\text{m}$
H4	Radius of Chip Center (referred to origin)	19.445	
H5	Distance Pattern to Drill Hole	8.5	
H6	Code Track Eccentricity (refer to center of inner hole)	± 0.2	
H7	Text S1 (readable on side of pattern)		RZ06S
H8	Text S2 (readable on side of pattern)		42-2048

TRACK LAYOUT

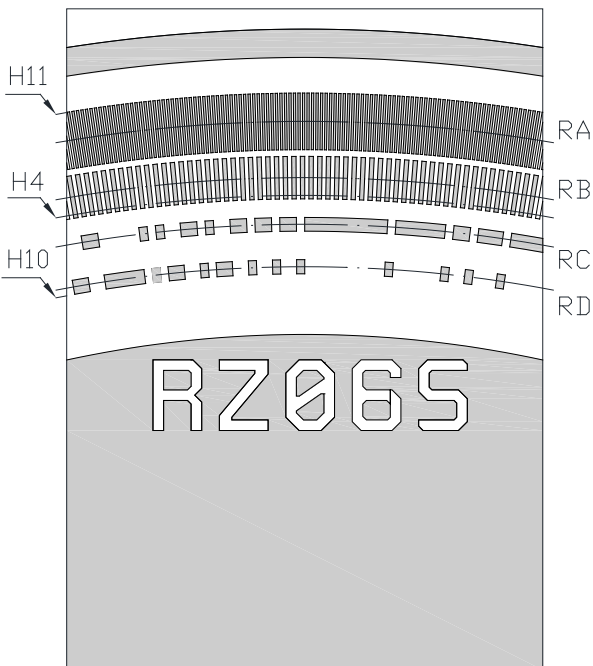

Chrome Side is Top Side

Item	Parameter	[mm]
H4	Radius of Chip Center (referred to origin)	19.445
H11	Code Pattern Radius: End	20.895
H10	Code Pattern Radius: Begin	18.340
RA	Track Radius Aux Sin/Cos 2048 PPR	20.495
RB	Track Radius Sin/Cos 1024 PPR	19.700
RC	Track Radius Random P	19.040
RD	Track Radius Random N	18.440

RZ06S 42-2048

iC-RZ4248 Encoder Disc and Code Description



Rev A4, Page 2/2

PHYSICAL DIMENSIONS: Phased Array

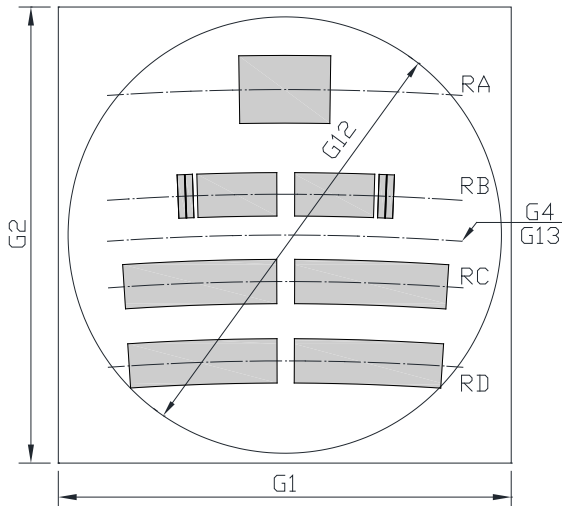

Item	Parameter	[mm]
G0	Name and Design Release: iC-RZ4248	
G1	Window Width: refer to IC datasheet	
G2	Window Height: refer to IC datasheet	
G4	Radius of Chip Center (referred to origin)	19.445
G12	Minimum Illumination Spot Diameter	>3.400
G13	Recommended Illumination Spot Center	19.445
RA	Track Radius Aux Sin/Cos 2048 PPR	20.495
RB	Track Radius Sin/Cos 1024 PPR	19.700
RC	Track Radius Random P	19.040
RD	Track Radius Random N	18.440

TRACK ASSIGNMENT:

Radius	Signal Period	Comments
RA	2048	Sin/Cos
RB	1024	Sin/Cos
RC	1024	Random P
RD	1024	Random N

iC-Haus expressly reserves the right to change its products and/or specifications. An Infoletter gives details as to any amendments and additions made to the relevant current specifications on our internet website www.ichaus.com/infoletter and is automatically generated and shall be sent to registered users by email.

Copying – even as an excerpt – is only permitted with iC-Haus' approval in writing and precise reference to source.

The data specified is intended solely for the purpose of product description and shall represent the usual quality of the product. In case the specifications contain obvious mistakes e.g. in writing or calculation, iC-Haus reserves the right to correct the specification and no liability arises insofar that the specification was from a third party view obviously not reliable. There shall be no claims based on defects as to quality in cases of insignificant deviations from the specifications or in case of only minor impairment of usability.

No representations or warranties, either expressed or implied, of merchantability, fitness for a particular purpose or of any other nature are made hereunder with respect to information/specification or the products to which information refers and no guarantee with respect to compliance to the intended use is given. In particular, this also applies to the stated possible applications or areas of applications of the product.

iC-Haus products are not designed for and must not be used in connection with any applications where the failure of such products would reasonably be expected to result in significant personal injury or death ("Safety-Critical Applications") without iC-Haus' specific written consent. Safety-Critical Applications include, without limitation, life support devices and systems. iC-Haus products are not designed nor intended for use in military or aerospace applications or environments or in automotive applications unless specifically designated for such use by iC-Haus.

iC-Haus conveys no patent, copyright, mask work right or other trade mark right to this product. iC-Haus assumes no liability for any patent and/or other trade mark rights of a third party resulting from processing or handling of the product and/or any other use of the product.

Software and its documentation is provided by iC-Haus GmbH or contributors "AS IS" and is subject to the ZVEI General Conditions for the Supply of Products and Services with iC-Haus amendments and the ZVEI Software clause with iC-Haus amendments (www.ichaus.com/EULA).