

# PR27S 14-256, iC-PR1456

## iC-PR Encoder Disc and Code Description



Rev B1, Page 1/2

### ORDERING INFORMATION

Type	Order Designation	Description/Options
Encoder Disc	PR27S# 14-256 (#: Material)	Code Disc 256 PPR, dia 14 mm

### PHYSICAL DIMENSIONS: Code Disc

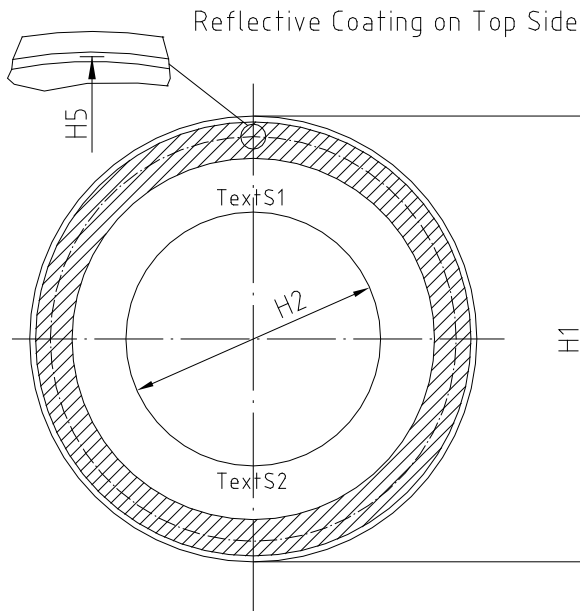

Item	Parameter	[mm]
H1	Outer Diameter	14.0
H2	Inner Diameter	2.0
H3	Thickness	t.b.d.
H5	Radius of Paddle Center	4.075
H6	Radius of Middle of AB Tracks	4.65
H9	Text S1	PR27S#
H10	Text S2	14-256

### TRACK LAYOUT: Code Disc

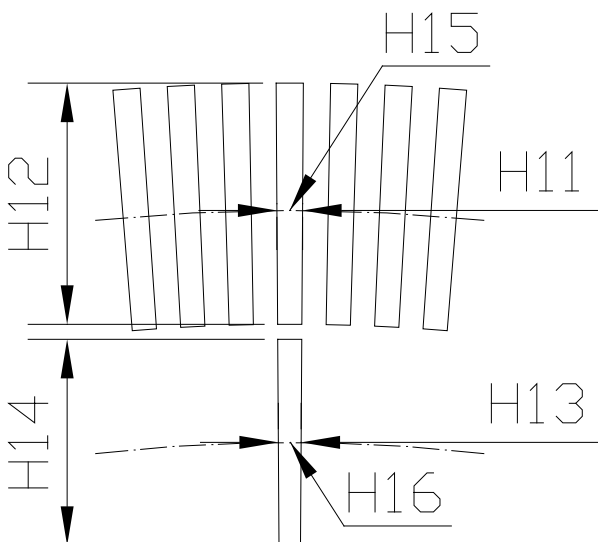

Item	Parameter	[um]
H11	AB-Track Width	57.0
H12	AB-Track Height	556.0
H13	Index-Track Width	50.4
H14	Index-Track Height	476.0
H15	Radius AB-Track (Disc)	4650.0
H16	Radius Index-Track ( Disc )	4100.0

# PR27S 14-256, iC-PR1456

## iC-PR Encoder Disc and Code Description



Rev B1, Page 2/2

### LAYOUT: System

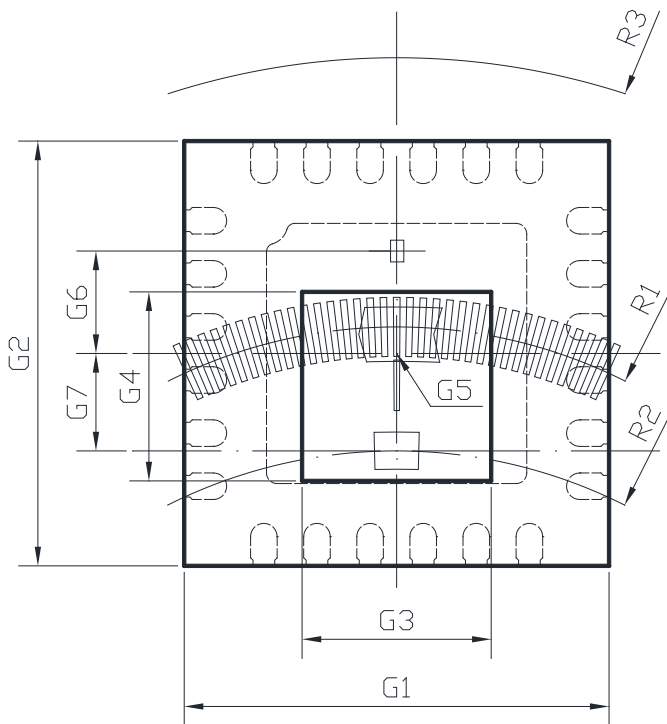

Item	Parameter	[mm]
G0	Name and Design Release oQFN24 4x4	iC-PR1456
G1	Width	4.0
G2	Height	4.0
G3	Window Width & Height	1.78
G4	Window Height	1.78
G5	Radius of Paddle Center	4.075
G6	Paddle Center vs. LED Center	0.965
G7	Paddle Center vs. Index Center	0.915
R1	Optical Radius AB-Track (Disc)	4.65
R2	Optical Radius Index-Track (Chip)	3.16
R3	Disc Outer Edge	7.0

iC-Haus expressly reserves the right to change its products and/or specifications. An Infoletter gives details as to any amendments and additions made to the relevant current specifications on our internet website [www.ichaus.com/infoletter](http://www.ichaus.com/infoletter) and is automatically generated and shall be sent to registered users by email. Copying – even as an excerpt – is only permitted with iC-Haus' approval in writing and precise reference to source.

The data specified is intended solely for the purpose of product description and shall represent the usual quality of the product. In case the specifications contain obvious mistakes e.g. in writing or calculation, iC-Haus reserves the right to correct the specification and no liability arises insofar that the specification was from a third party view obviously not reliable. There shall be no claims based on defects as to quality in cases of insignificant deviations from the specifications or in case of only minor impairment of usability.

No representations or warranties, either expressed or implied, of merchantability, fitness for a particular purpose or of any other nature are made hereunder with respect to information/specification or the products to which information refers and no guarantee with respect to compliance to the intended use is given. In particular, this also applies to the stated possible applications or areas of applications of the product.

iC-Haus products are not designed for and must not be used in connection with any applications where the failure of such products would reasonably be expected to result in significant personal injury or death ("Safety-Critical Applications") without iC-Haus' specific written consent. Safety-Critical Applications include, without limitation, life support devices and systems. iC-Haus products are not designed nor intended for use in military or aerospace applications or environments or in automotive applications unless specifically designated for such use by iC-Haus.

iC-Haus conveys no patent, copyright, mask work right or other trade mark right to this product. iC-Haus assumes no liability for any patent and/or other trade mark rights of a third party resulting from processing or handling of the product and/or any other use of the product.

Software and its documentation is provided by iC-Haus GmbH or contributors "AS IS" and is subject to the ZVEI General Conditions for the Supply of Products and Services with iC-Haus amendments and the ZVEI Software clause with iC-Haus amendments ([www.ichaus.com/EULA](http://www.ichaus.com/EULA)).