

MB3U-I2C

BiSS(SS) AND I2C-TO-PC ADAPTER (USB)



Rev D1, Page 1/10

FEATURES

- ◆ Simple evaluation and implementation of iC-Haus components
- ◆ BiSS/SSI Interface (9-pin D-sub connector)
- ◆ SPI/I2C/2-wire Interface (2x5-pin connector)
- ◆ 5 V and 12 V sensor supply
- ◆ Fast communication:
10 MHz (BiSS), 4 MHz (SSI), 6 MHz (SPI), 100 kHz (I2C)
- ◆ USB 2.0 compatible PC interface
- ◆ Field capable design:
plastic case, field interfaces, powered via USB

APPLICATIONS

- ◆ Application development using iC-Haus components
- ◆ Application debugging using iC-Haus components

SYSTEM VIEW

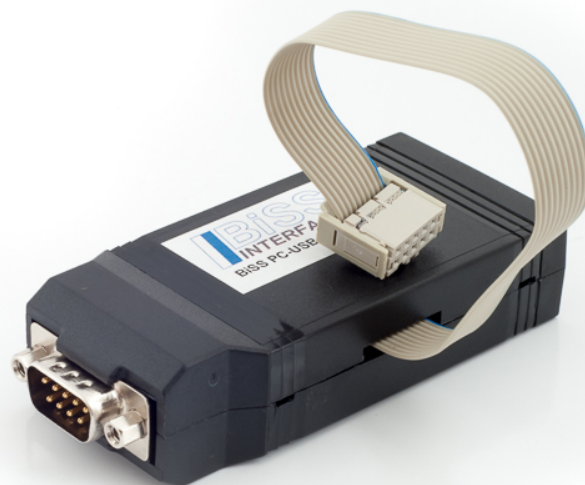

MB3U-I2C

BiSS(SSI) AND I2C-TO-PC ADAPTER (USB)



Rev D1, Page 2/10

DESCRIPTION

MB3U-I2C is a PC USB adapter intended to enable a simple evaluation of iC-Haus' integrated circuits using the corresponding evaluation board and GUI software. The adapter provides differential, galvanically isolated RS422 master interfaces for BiSS and SSI via its 9-pin D-sub connector as well as single-ended master interface for SPI, I2C and 2-wire via its 2x5-pin connector. The adapter is compatible to USB 2.0. Drivers for Windows 10 and Linux are provided.

9-Pin D-sub (BiSS/SSI) Connector:

- Differential 5 V RS422 and single-ended BiSS/SSI master interface
- BiSS C and BiSS B protocol support
- Suitable for up to 3 BiSS slaves
- Maximum bit rate: 10 MBit/s (BiSS), 4 MBit/s (SSI)
- Sensor supply voltages: VDD = 5 V and VB = 12 V
- Max. load: 150 mA, powered via USB
- Max. load: 250 mA (VDD) / 500 mA (VB), powered via wall adapter
- Powered via USB or wall adapter (optionally available)
- Galvanic isolation

2x5-Pin (SPI/I2C/2-wire) Connector:

- SPI and I2C master interface
- Suitable for single master systems
- Maximum bit rate: 6 MBit/s (SPI), 100 kBit/s (I2C)
- Sensor supply voltage: VDD = 5 V
- Max. load: 200 mA, powered via USB (no power via wall adapter available)
- No galvanic isolation

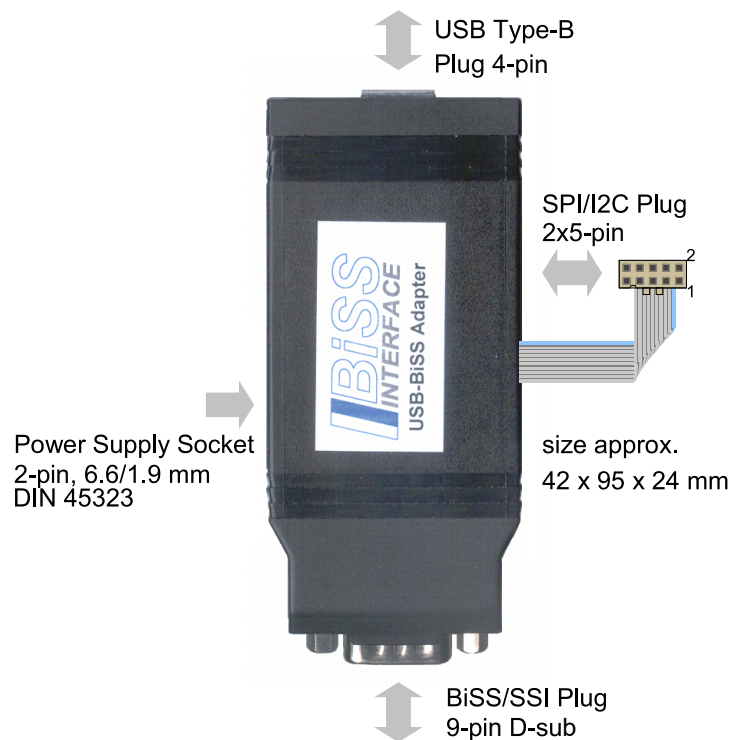

Figure 1: iC-MB3 iCSY MB3U-I2C

MB3U-I2C

BiSS(SSI) AND I2C-TO-PC ADAPTER (USB)



Rev D1, Page 3/10

CONNECTORS

PIN CONFIGURATION

9-pin D-sub (male) for BiSS/SSI

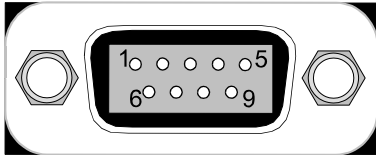

PIN FUNCTIONS

No. Name Function

1	VB	12V sensor supply voltage output
2	MA+	Clock output (positive)
3	MA-	Clock output (negative)
4	VDD	5V sensor supply voltage output
5	MO-	Master data output (negative) (constant high)
6	GND	Ground (0V)
7	SL+	Master data input (positive)
8	SL-	Master data input (negative)
9	MO+	Master data output (positive) (constant low)

PIN CONFIGURATION

2x5-pin (RM2.54, female) for SPI

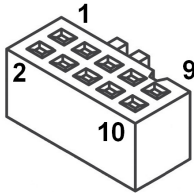

PIN FUNCTIONS

No. Name Function

1	SCLK	Serial clock line
2	GND	Ground (0V)
3	n.c.	Reserved
4	VDD	5V sensor supply voltage output
5	n.c.	Reserved
6	n.c.	Reserved
7	MOSI	Serial data line output
8	NCS	Chip select (active low)
9	MISO	Serial data line input
10	GND	Ground (0V)

PIN CONFIGURATION

2x5-pin (RM2.54, female) for I2C

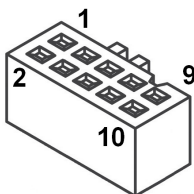

PIN FUNCTIONS

No. Name Function

1	SCL	Serial clock line
2	GND	Ground (0V)
3	n.c.	Reserved
4	VDD	5V sensor supply voltage output
5	n.c.	Reserved
6	n.c.	Reserved
7	SDA	Serial data line
8	n.c.	Reserved
9	SDA_IN	Serial data line input (for legacy products)
10	GND	Ground (0V)

MB3U-I2C

BiSS(SS) AND I2C-TO-PC ADAPTER (USB)



Rev D1, Page 4/10

PIN CONFIGURATION

External Power Supply
(DIN 45323)

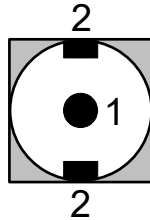

PIN FUNCTIONS

No. Name Function

- | | | |
|---|------|---|
| 1 | GND | Ground (0 V) |
| 2 | Vext | 12 V power supply voltage input
(500 mA) |

PIN CONFIGURATION

USB Type B

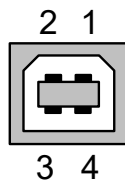

PIN FUNCTIONS

No. Name Function

- | | | |
|---|------|------------------------------------|
| 1 | Vusb | 5 V USB power supply voltage input |
| 2 | D- | Data - |
| 3 | D+ | Data + |
| 4 | GND | Ground (0 V) |

MB3U-I2C

BiSS(SSI) AND I2C-TO-PC ADAPTER (USB)



Rev D1, Page 5/10

ABSOLUTE MAXIMUM RATINGS

These ratings do not imply operating conditions; functional operation is not guaranteed. Beyond these ratings device damage may occur.

Item No.	Symbol	Parameter	Conditions	Min. Max.		Unit
				Min.	Max.	
G001	Vext	External Power Supply Input			20	V
G002	I(Vext)	Power Supply Input Current			1	A
G003	V()	Voltage at input signals SL+, SL-		-7	+7	V
G004	I()	Output Current at output signals MA+, MA-, MO+, MO-,	high low (according to Texas Instruments™ SN65LBC179 datasheet)	60	-60	mA mA
G005	P(VB)	Load at VB			6	W
G006	P(VDD)	Load at VDD			1	W
G007	GI	Galvanic Isolation	For 9-pin D-sub (male) for BiSS/SSI and external power supply connector only		500	V
G008	V()	Input Voltage at SDA	(according to FTDI Chip™ FT2232 datasheet)	-0.5	V_USB + 0.5	V
G009	I()	Output Current at SCL, SCLK, SDA, NCS	(according to FTDI Chip™ FT2232 datasheet)		24	mA

THERMAL DATA

Item No.	Symbol	Parameter	Conditions	Min. Typ. Max.			Unit
				Min.	Typ.	Max.	
T01	Ta	Operating Ambient Temperature Range	Relative humidity: 5%...95% (non condensing)	0		30	°C

All voltages are referenced to ground unless otherwise stated.

All currents flowing into the device pins are positive; all currents flowing out of the device pins are negative.

MB3U-I2C

BiSS(SSI) AND I2C-TO-PC ADAPTER (USB)



Rev D1, Page 6/10

ELECTRICAL CHARACTERISTICS

Operating conditions: Vusb = 4.5 V...5.5 V, Ta = 0...30 °C unless otherwise noted.

Item No.	Symbol	Parameter	Conditions				Unit
				Min.	Typ.	Max.	
Power Supply Input: Vusb, Vext							
001	Vusb	Power Supply Voltage Input	By USB port	4.5	5.0	5.5	V
002	I(Vusb)	Current Consumption	From USB port			500	mA
003	Vext	Permissible External Supply	Typical: Vext = 12 V, 500 mA	9	12	15	V
Field Power Supply Output: VB, VDD							
101	VB	VB Supply Output	USB powered; With wall adapter;	9	12 Vext	13	V V
102	I(VB)	Permissible VB Load Current	USB powered; wall adapter (12 V, 500 mA) powered; no other load at 9-pin D-sub (BiSS/SSI) and 2x5-Pin (SPI/I2C/2-wire) connector.			150 500	mA mA
103	VDD	VDD Supply Output	At 2x5-Pin (SPI/I2C/2-wire) connector and 9-pin D-sub (BiSS/SSI) connector	4.5	5	5.5	V
104	I(VDD)	Permissible VDD Load Current at 9-pin D-sub (BiSS/SSI) connector	USB powered; With wall adapter; no other load at 9-pin D-sub (BiSS/SSI) and 2x5-Pin (SPI/I2C/2-wire) connector.			150 250	mA mA
105	I(VDD)	Permissible VDD Load Current at 2x5-Pin (SPI/I2C/2-wire) connector	USB powered; no other load at 9-pin D-sub (BiSS/SSI) and 2x5-Pin (SPI/I2C/2-wire) connector.			200	mA
9-Pin D-sub (BiSS/SSI) Connector: MA+, MA-, SL+, SL-, MO+, MO-							
201	Vout()	Diff. Voltage Output at MA+, MA-	RL = 54 Ω (according to Texas Instruments™ SN65LBC179 datasheet)	1.1	2.2	5	V
202	fclk()	Clock Frequency Output at MA+, MA-				10	MHz
203	Vt()hi	Input Threshold Voltage hi at SL+ vs. SL-	Io = -8 mA (according to Texas Instruments™ SN65LBC179 datasheet)			0.2	V
204	Vt()lo	Input Threshold Voltage lo at SL+ vs. SL-	Io = 8 mA (according to Texas Instruments™ SN65LBC179 datasheet)	-0.2			V
205	Vt()hys	Input Hysteresis	(according to Texas Instruments™ SN65LBC179 datasheet)		45		mV
206	Rin()	Input Resistance between SL+ and SL-	Line Termination		120		Ω
2x5-Pin (SPI/I2C/2-wire) Connector: SCLK, MOSI, MISO, NCS, SCL, SDA							
301	Vt()	Input Threshold Voltage at MISO, SDA	Standard level (according to FTDI Chip™ FT2232 datasheet)	1.2	1.3	1.5	V
302	Vt()hys	Input Hysteresis at MISO, SDA	Standard level (according to FTDI Chip™ FT2232 datasheet)	50	30	25	mV
303	Vs()hi	Saturation Voltage hi at SCLK, MOSI, NCS, SCL, SDA	I(source) = -2 mA, standard level (according to FTDI Chip™ FT2232 datasheet)	3.2	4.1	4.9	V
304	Vs()lo	Saturation Voltage lo at SCLK, MOSI, NCS, SCL, SDA	I(sink) = 2 mA, standard level (according to FTDI Chip™ FT2232 datasheet)	0.3	0.4	0.6	V

MB3U-I2C

BiSS(SSI) AND I2C-TO-PC ADAPTER (USB)



Rev D1, Page 7/10

RELATED PRODUCTS AND DOCUMENTATION

- BiSS Software GUI (with/without LabVIEW™ RTE)
→ www.ichaus.de/biss_gui_rte
→ www.ichaus.de/biss_gui
- BiSS Software DLL
→ https://www.ichaus.de/BiSS_1SL_interface
- IC Configuration Software GUI
→ Please refer to the specific product website at www.ichaus.de
- BiSS Protocol Description
→ www.biss-interface.com/biss_c_en

FUNCTIONAL NOTES



This evaluation kit is intended to be used for development, demonstration and evaluation purposes using iC-Haus products only.

BiSS/SSI Data Acquisition

BiSS and SSI data frames are triggered by software. Equidistant data acquisition (e.g. for using the Fast Reader window of the BiSS Software GUI or for sensor calibration) is not possible.

BiSS/SSI Hardware Interface

Most iC-Haus evaluation boards implement a differential 5 V RS422 interface. However, a voltage divider is connected to the data input line SL- enabling a reference voltage suitable also for single-ended BiSS/SSI applications at pins MA+, SL+, MO+. The schematic of the input/output stage is shown in Figure 2.

Galvanic Isolation

BiSS signals MA+, MA-, MO+, MO-, SL+ and SL- as well as the supply voltages VDD and VB are galvanically isolated. At the I2C/SPI/2-wire interface no galvanic isolation is available. USB and field GND potentials must be equal to prevent ground loops and potential differences.

BiSS Power Supply

Both sensor supply voltages VDD = 5 V and VB = 12 V are always enabled.

Data Clock Frequency

The clock frequency at MA+/MA- (BiSS/SSI) and SCLK (SPI) can be adjusted by software. Table 1 lists the possible frequency range.

FREQ_SCD(4:0)		R/W
Code	Single-cycle data clock frequency (f_{clk})	
0x00 ...0x0F	$f_{sys} / [2 * (Code + 1)]$	
0x10	"not permitted"	
0x11 ...0x1F	$f_{sys} / [20 * (Code - 15)]$	
Notes	$f_{sys} = 20 \text{ MHz}$ (internal system clock)	

Table 1: Single-cycle data clock frequency at MA+/MA- and SCLK

MO Line Control

The MO+ is connected to GND and MO- is connected to VDD as shown in Figure 2. Thus, MO line control is disabled and the start bit of a BiSS frame cannot be delayed by the BiSS master.

MB3U-I2C

BiSS(SSI) AND I2C-TO-PC ADAPTER (USB)



Rev D1, Page 8/10

SCHEMATIC

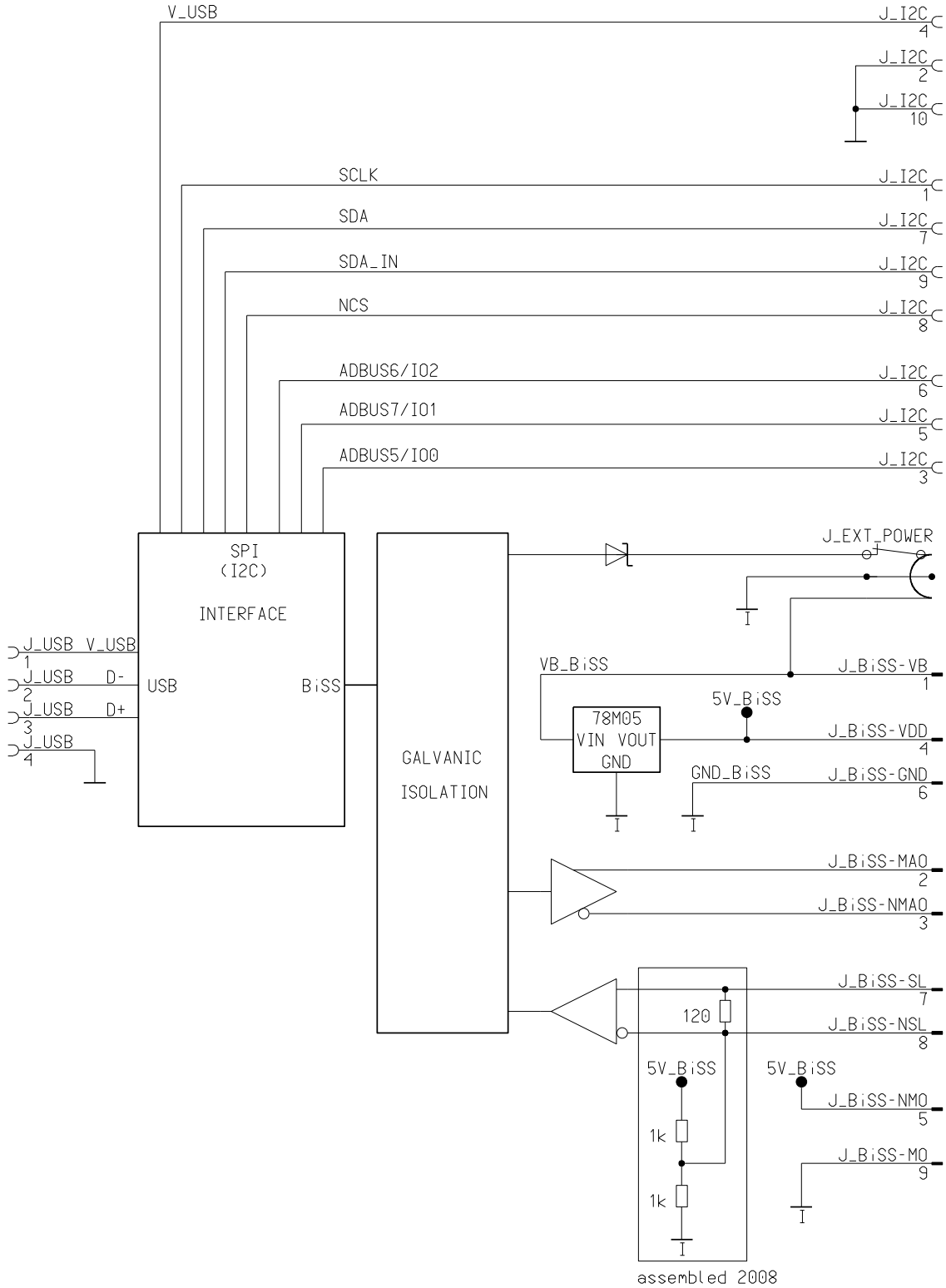

Figure 2: Power supply routing of MB3U-I2C

MB3U-I2C

BiSS(SSI) AND I2C-TO-PC ADAPTER (USB)



Rev D1, Page 9/10

REVISION HISTORY

Rel.	Rel. Date*	Chapter	Modification	Page
A1 ...A6	2005-02-08		Refer to the revision history of the release.	

Rel.	Rel. Date*	Chapter	Modification	Page
B1 ...B6	2010-01-21		Refer to the revision history of the release.	

Rel.	Rel. Date*	Chapter	Modification	Page
C1	2017-03-07	All	Datasheet revised	All
		APPLICATION SOFTWARE	BiSS Reader details updated to the all new BiSS Reader F1 release	8 ... 12

Rel.	Rel. Date*	Chapter	Modification	Page
C2	2017-05-26	CONNECTORS	12V replaced by 5V logic power supply at I2C	3

Rel.	Rel. Date*	Chapter	Modification	Page
C3	2017-07-19	ORDERING INFORMATION	ORDERING INFORMATION retrieved	16

Rel.	Rel. Date*	Chapter	Modification	Page
C4	2018-01-16	ORDERING INFORMATION	Adding general information: the box includes a cable USB (type A ↔ B)	16

Rel.	Rel. Date*	Chapter	Modification	Page
D1	2022-08-08	All	Overall update Updated Subtitle	All
		FEATURES	Reviewed features	1
		APPLICATIONS	Reviewed applications	1
		DESCRIPTION	Removed BUA note	2
		CONNECTORS	Renamed n.a. → n.c. SPI clock pin renamed: SCL → SCLK USB type B added. External Power Supply voltage input updated	3f
		SCHEMATIC	Updated schematic	8
		ORDERING INFORMATION	MB3U options removed	10

iC-Haus expressly reserves the right to change its products, specifications and related supplements (together the Documents). A Datasheet Update Notification (DUN) gives details as to any amendments and additions made to the relevant Documents on our internet website www.ichaus.com/DUN and is automatically generated and shall be sent to registered users by email.

Copying – even as an excerpt – is only permitted with iC-Haus' approval in writing and precise reference to source.

The data and predicted functionality is intended solely for the purpose of product description and shall represent the usual quality and behaviour of the product. In case the Documents contain obvious mistakes e.g. in writing or calculation, iC-Haus reserves the right to correct the Documents and no liability arises insofar that the Documents were from a third party view obviously not reliable. There shall be no claims based on defects as to quality and behaviour in cases of insignificant deviations from the Documents or in case of only minor impairment of usability.

No representations or warranties, either expressed or implied, of merchantability, fitness for a particular purpose or of any other nature are made hereunder with respect to information/specification resp. Documents or the products to which information refers and no guarantee with respect to compliance to the intended use is given. In particular, this also applies to the stated possible applications or areas of applications of the product.

iC-Haus products are not designed for and must not be used in connection with any applications where the failure of such products would reasonably be expected to result in significant personal injury or death (*Safety-Critical Applications*) without iC-Haus' specific written consent. Safety-Critical Applications include, without limitation, life support devices and systems. iC-Haus products are not designed nor intended for use in military or aerospace applications or environments or in automotive applications unless specifically designated for such use by iC-Haus.

iC-Haus conveys no patent, copyright, mask work right or other trade mark right to this product. iC-Haus assumes no liability for any patent and/or other trade mark rights of a third party resulting from processing or handling of the product and/or any other use of the product.

Software and its documentation is provided by iC-Haus GmbH or contributors "AS IS" and is subject to the ZVEI General Conditions for the Supply of Products and Services with iC-Haus amendments and the ZVEI Software clause with iC-Haus amendments (www.ichaus.com/EULA).

* Release Date format: YYYY-MM-DD

MB3U-I2C

BiSS(SSI) AND I2C-TO-PC ADAPTER (USB)



Rev D1, Page 10/10

ORDERING INFORMATION

Type	Package	Options	Order Designation
MB3U-I2C	MB3U-I2C	The box includes <ul style="list-style-type: none">• MB3U-I2C• USB cable (type A ↔ B)	iC-MB3 iCSY MB3U-I2C
MB3U-I2C + PS230	MB3U-I2C	The box includes <ul style="list-style-type: none">• MB3U-I2C• USB cable (type A ↔ B)• Switched-mode power supply (230VAC → 12 V; 500 mA)	iC-MB3 iCSY MB3U-I2C-PS230

Please send your purchase orders to our order handling team:

Fax: +49 (0) 61 35 - 92 92 - 692

E-Mail: dispo@ichaus.com

For technical support, information about prices and terms of delivery please contact:

iC-Haus GmbH
Am Kuemmerling 18
D-55294 Bodenheim
GERMANY

Tel.: +49 (0) 61 35 - 92 92 - 0
Fax: +49 (0) 61 35 - 92 92 - 192
Web: <http://www.ichaus.com>
E-Mail: sales@ichaus.com

Appointed local distributors: http://www.ichaus.com/sales_partners