

iC-MB3

BiSS INTERFACE MASTER, 1-Chan./3-Slaves



Rev D1, Page 1/26

FEATURES

- ◆ Bidirectional *BiSS* sensor communication with up to 3 slaves
- ◆ Supports SSI protocol for unidirectional communication
- ◆ Synchronous sensor data acquisition with cyclic transfer at data rates of up to 10 Mbit/s
- ◆ Command and slave register operations during cyclic data transfers
- ◆ Data lengths of up to 64 bits for sensor data, independently scalable for each slave
- ◆ Automatic compensation of line delays, measurement and conversion times
- ◆ Data verification by CRC polynomials of up to 8 bits, adjustable per slave
- ◆ Separate memory banks enable free controller access during *BiSS* sensor data transfers
- ◆ 32 bytes of intermediate memory to ease bidirectional slave register communications
- ◆ Parallel controller interface with an 8-bit data/address bus services Intel and Motorola devices
- ◆ Serial controller communication by SPI™-compatible mode
- ◆ Single 3 to 5V supply, industrial temperature range

APPLICATIONS

- ◆ Bidirectional device communication in multisensor systems
- ◆ Position measurement with linear or angular encoders
- ◆ Drive systems (motor feedback)

PACKAGES

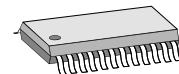

TSSOP24

BLOCK DIAGRAM

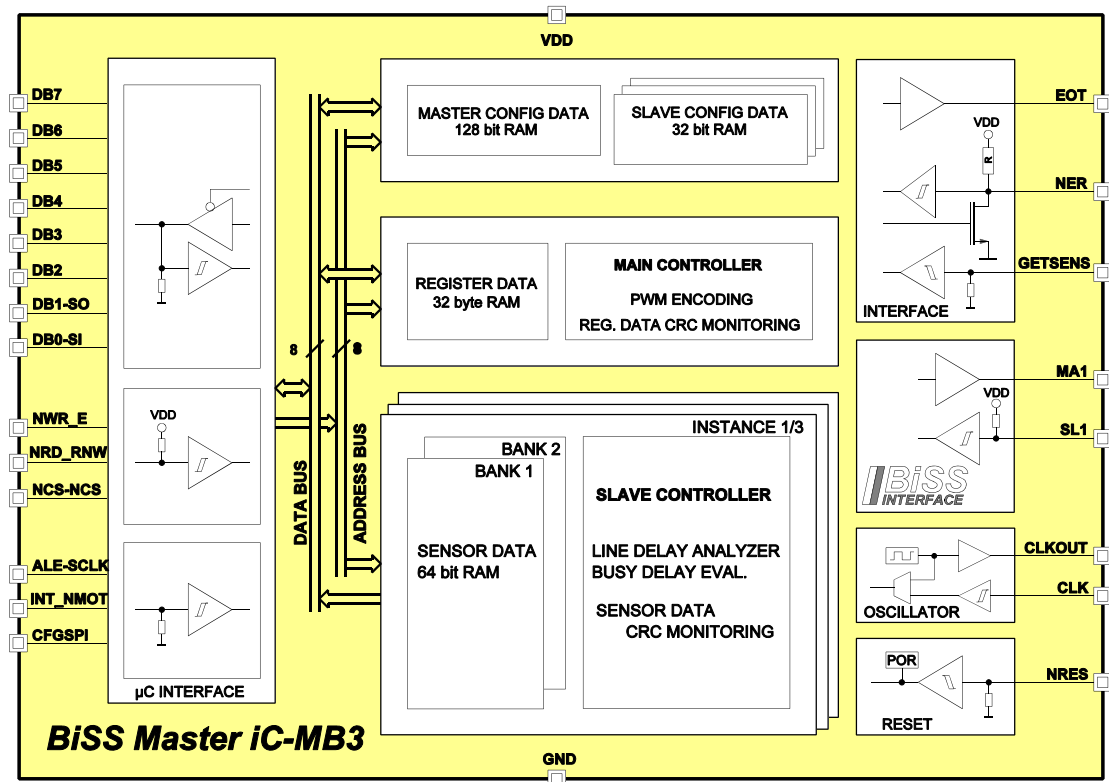

SPI is a trademark of MOTOROLA, Inc.

iC-MB3

BiSS INTERFACE MASTER, 1-Chan./3-Slaves



Rev D1, Page 2/26

DESCRIPTION

iC-MB3 is a single-chip *BiSS/SSI* interface controller featuring an 8-bit bus interface to industrial standard microcontrollers. An additional SPI interface mode also enables serial communication between iC-MB3 and the connected microcontroller.

One to three *BiSS* devices can be attached to the sensor side of the device. These are connected up to clock line MA1 and data return line SL1 using RS422 transceivers (Figure 1). The *BiSS* devices can be connected directly in noise-free environments.

A maximum of three *BiSS* slaves is supported, each with their own independently scalable data sections encompassing:

- 1) Sensor data from 0 to 64 bits (for measurement data, alarms and warnings)
- 2) Register data with 128 bytes per slave ID (e.g. for device parameters).

iC-MB3 provides dual RAM memory banks for each slave, enabling flexible access of the microcontroller while new sensor data is being read in. A 32-byte intermediate memory supports register transfers.

Sensor data acquisition is started by a microcontroller command or via pin GETSENS. Alternatively, iC-MB3 can also read in new sensor data automatically; the cycle time in this instance can be set as required.

The end of sensor data acquisition and readin is signaled at pin EOT by a high; if faults occur during transmission pin NER signals a low. Errors in communication can be verified by the microcontroller via a status register; a system error message can also enter this register if bidirectional message pin NER is kept low by external intervention.

iC-MB3 generates a clock signal for sensor communication using an internal 20 MHz oscillator. The clock can also be supplied externally.

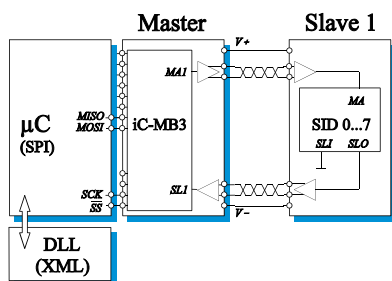

Figure 1: Point-to-point connection of iC-MB3 and one bus subscriber. This can use 1 to 8 slave IDs (SID).

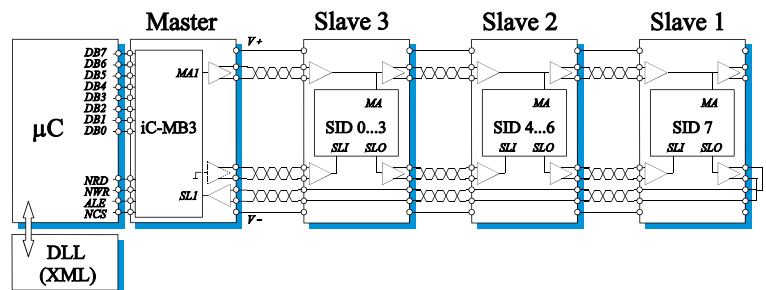

Figure 2: Example network of iC-MB3 and three subscribers. All 8 possible slave IDs (SIDs) are used distributed.

iC-MB3

BiSS INTERFACE MASTER, 1-Chan./3-Slaves



Rev D1, Page 3/26

PACKAGES TSSOP24 to JEDEC Standard

PIN CONFIGURATION

TSSOP24 4.4 mm, lead pitch 0.65 mm
(top view)

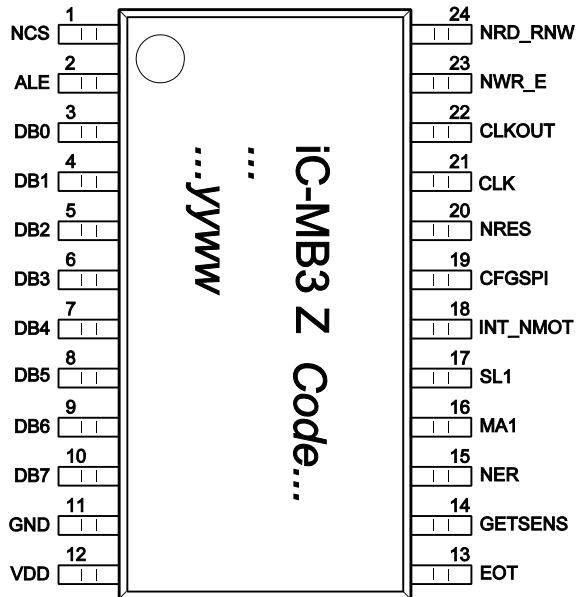

PIN FUNCTIONS

No.	Name	Function
1	NCS	Chip Select Input, low active
2	ALE-SCLK	Address Latch Enable Input
3	DB0	Data Bus
4	DB1	Data Bus
5	DB2	Data Bus
6	DB3	Data Bus
7	DB4	Data Bus
8	DB5	Data Bus
9	DB6	Data Bus
10	DB7	Data Bus
11	GND	Ground
12	VDD	+3.3 ... +5V Supply Voltage
13	EOT	End-Of-Transmission Output
14	GETSENS	Sensor Data Request Input
15	NER	Error Message Input/Output, low active
16	MA1	BiSS Clock/Data Line Output
17	SL1	BiSS Data Line Input
18	INT_NMOT	Mode Select (Intel = 1, Motorola = 0)*
19	CFGSPI	Serial/Parallel Mode Select Input (serial SPI = 1, parallel = 0)
20	NRES	Reset Input, low active
21	CLK	External Clock Input
22	CLKOUT**	Clock Output
23	NWR_E	Write Input, low active (Intel) Enable Input, high active (Motorola)
24	NRD_RNW	Read Input, low active (Intel) Read/Not-Write Select Input (Motorola)

Serial SPI Communication Mode (CFGSPI = 1):

1	NCS	Chip Select Input, low active
2	SCLK	SPI Clock Input
3	SI	SPI Serial Data Input
4	SO	SPI Serial Data Output

* only when CLKENI = 1 else no signal
** on SPI no effect

ABSOLUTE MAXIMUM RATINGS

Values beyond which damage may occur; device operation is not guaranteed.

Item	Symbol	Parameter	Conditions	Fig.			Unit
					Min.	Max.	
G001	VDD	Supply Voltage VDD			-0.3	6	V
G002	I(VDD)	Current in VDD			-20	30	mA
G003	V()	Voltage at all pins, excluding VDD and GND	$V() \leq VDD + 0.3 V$		-0.3	6	V
G004	I()	Current in all pins excluding VDD and GND			-10	10	mA
E001	Vesd()	ESD Susceptibility at all pins	HBM, 100 pF discharged through 1.5 k Ω			2	kV
TG1	Tj	Operating Junction Temperature			-40	150	°C
TG2	Ts	Storage Temperature Range			-40	150	°C

THERMAL DATA

Operating Conditions: VDD = 3 ... 5 V

Item	Symbol	Parameter	Conditions	Fig.				Unit
					Min.	Typ.	Max.	
T1	Ta	Operating Ambient Temperature Range (extended range to -40 °C is available on request)			-25		85	°C

All voltages are referenced to ground unless otherwise noted.

All currents into the device pins are positive; all currents out of the device pins are negative.

ELECTRICAL CHARACTERISTICS

Operating Conditions: VDD = 3 ... 5.5 V, Tj = -25 ... +125 °C, unless otherwise noted

Item	Symbol	Parameter	Conditions	Tj °C	Fig.				Unit
						Min.	Typ.	Max.	
Total Device									
001	VDD	Permissible Supply Voltage				3		5.5	V
002	I(VDD)	Supply Current in VDD	outputs not loaded, f(CLK) = 20 MHz					20	mA
003	Vc()hi	Clamp Voltage hi at all pins excluding VDD, GND	Vc()hi = V() - VDD, I() = 1 mA; outputs tristate			0.3		1.6	V
004	Vc()lo	Clamp Voltage lo at all pins excluding VDD, GND	I() = -1mA; outputs tristate			-1.6		-0.3	V
Control Interface: EOT, NER, GETSENS									
201	Vs()hi	Saturation Voltage hi at EOT	Vs()hi = VDD - V(); I() = -4 mA VDD = 3 V; I() = -2 mA					400 400	mV mV
202	Vs()lo	Saturation Voltage lo at EOT, NER	I() = 4 mA VDD = 3 V, I() = 2 mA					420 420	mV mV
203	Vt()hi	Threshold Voltage hi at NER, GETSENS						2	V
204	Vt()lo	Threshold Voltage lo at NER, GETSENS	VDD = 3 V			0.8 0.4			V V
205	Vt()hys	Threshold Voltage Hysteresis at NER, GETSENS				300	500		mV
206	Ipu()	Pull-Up Current at NER vs. VDD	V() = 0 ... VDD - 1.5 V			-600	-300	-60	µA
207	Ipd()	Pull-Down Current at GETSENS vs. GND	V() = 1.5 V ... VDD			4	35	70	µA
BiSS Interface: MA1, SL1									
301	Vs(MA1)hi	Saturation Voltage hi	Vs()hi = VDD - V(); I() = -4 mA VDD = 3 V, I() = -2 mA					400 400	mV mV
302	Vs(MA1)lo	Saturation Voltage lo	I() = 4 mA VDD = 3 V, I() = 2 mA					420 420	mV mV
303	Vt(SL1)hi	Threshold Voltage hi						2	V
304	Vt(SL1)lo	Threshold Voltage lo	VDD = 3 V			0.8 0.4			V V
305	Vt(SL1)hys	Threshold Voltage Hysteresis				300	500		mV
306	Ipu(SL1)	Pull-Up Strom vs. VDD	V() = 0 ... VDD - 1.5 V			-70	-35	-5	µA
µC Interface: bidirectional data bus DB7 ... 0, Inputs NWR_E, NRD_RNW, NCS, ALE, INT_NMOT, CFGSPI									
401	Vs()hi	Saturation Voltage hi at DB7...0	Vs()hi = VDD - V(); I() = -4 mA VDD = 3 V, I() = -2 mA					400 400	mV mV
402	Vs()lo	Saturation Voltage lo at DB7...0	I() = 4 mA VDD = 3 V, I() = 2 mA					420 420	mV mV
403	Vt()hi	Threshold Voltage hi						2	V
404	Vt()lo	Threshold Voltage lo	VDD = 3 V			0.8 0.4			V V
405	Vt()hys	Threshold Voltage Hysteresis				300	500		mV
406	Ipd()	Pull-Down Current at DB7...0, ALE, CFGSPI, INT_NMOT to GND	V() = 1.5 V ... VDD			4	35	70	µA
407	Ipu()	Pull-Up Current at NRD_RNW, NWR_E, NCS vs.VDD	V() = 0 ... VDD - 1.5 V			-70	-35	-4	µA

ELECTRICAL CHARACTERISTICS

Operating Conditions: VDD = 3 ... 5.5 V, Tj = -25 ... +125 °C, unless otherwise noted

Item	Symbol	Parameter	Conditions	Tj °C	Fig.				Unit
						Min.	Typ.	Max.	
Oscillator: CLK, CLKOUT									
501	f(CLK)	Permissible Clock Rate at CLK					20	25	MHz
502	f(CLKOUT)	Oscillator Clock Frequency	VDD = 5 V, CLKENI = 1				20		MHz
503	Vt(CLK)hi	Threshold Voltage hi						2	V
504	Vt(CLK)lo	Threshold Voltage lo	VDD = 3 V			0.8 0.4			V V
505	Vt(CLK)hys	Threshold Voltage Hysteresis				300	500		mV
506	Ipd()	Pull-Down Current at CLK	V() = 1.5 V ... VDD			4	35	70	µA
507	Vs()hi	Saturation Voltage hi at CLKOUT	Vs()hi = VDD - V(); I() = -4 mA VDD = 3 V, I() = -2 mA					400 400	mV mV
508	Vs()lo	Saturation Voltage lo at CLKOUT	I() = 4 mA VDD = 3 V, I() = 2 mA					420 420	mV mV
509	Isc()hi	Short-Circuit Current hi at CLKOUT	V() = 0			-30	-12	-4	mA
510	Isc()lo	Short-Circuit Current lo at CLKOUT	V() = VDD			5	23	50	mA
Reset: NRES									
601	VDDoff	Undervoltage Reset	VDD decreasing				1.6		V
602	VDDon	Undervoltage Release	VDD increasing				1.75		V
603	VDDhys	Undervoltage Hysteresis	VDDhys = VDDon - VDDoff				100		mV
604	Vt()hi	Threshold Voltage hi						2	V
605	Vt()lo	Threshold Voltage lo	VDD = 3 V			0.8 0.4			V V
606	Vt()hys	Threshold Voltage Hysteresis				300	500		mV
607	Ipd()	Pull-Down Current	V() = 1.5 V ... VDD			4	35	70	µA
608	td(res)	Required Reset Pulse Duration at NRES				250			ns

OPERATING REQUIREMENTS: μ C Interface, INTEL mode

Operating conditions: CFGSPI = 0, INT_NMOT = 1
 VDD = 3 ... 5.5V, Ta = -25 ... 85 °C; input levels lo = 0 ... 0.45 V, hi = 2.4 V ... VDD

Item	Symbol	Parameter	Conditions	Fig.	Timing		Unit
					Min.	Max.	
I01	tsAA	Setup Time: Address stable before ALE hi-lo		3/4	15		ns
I02	tAh	Signal Duration: ALE at high level		3/4	10		ns
I03	tsCA	Setup Time: NCS hi-lo until ALE hi-lo		3/4	10		ns
I04	thAA	Hold Time: Address stable after ALE hi-lo		3/4	15		ns
I05	tsAW	Setup Time: ALE hi-lo until NWR_E hi-lo		3	0		ns
I06	tWI	Signal Duration: NWR_E at low level		3	10		ns
I07	tsDW	Setup Time: Data stable before NWR_E lo-hi		3	15		ns
I08	thWD	Hold Time: Data stable after NWR_E lo-hi		3	0		ns
I09	thWC	Hold Time: NCS lo after NWR_E lo-hi		3	0		ns
I10	thWA thRA	Hold Time: ALE lo after NWR_E lo-hi	NCS = lo	3/4	15		ns
I11	tsAR	Setup Time: ALE hi-lo until NRD_RNW hi-lo		4	0		ns
I12	tRI	Signal Duration: NRD_RNW at low level		4	70		ns
I13	tpRD1	Propagation Delay: Data stable after NRD_RNW hi-lo		4	0	25	ns
I14	tpRD2	Propagation Delay: Data Bus high impedance after NRD_RNW lo-hi		4	0	25	ns

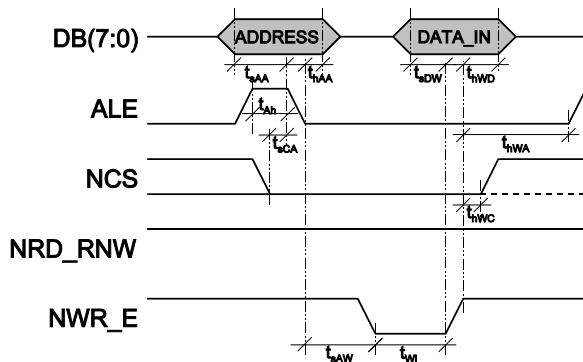

Figure 3: Write cycle (Intel Mode)

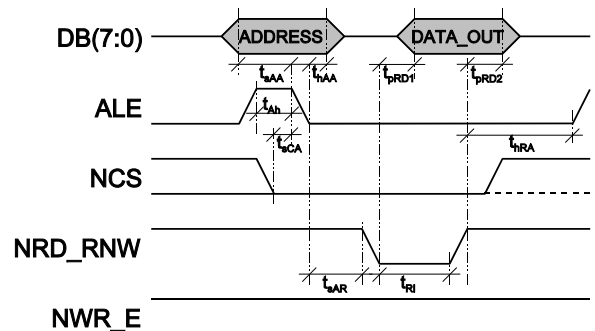

Figure 4: Read cycle (Intel Mode)

OPERATING REQUIREMENTS: μ C Interface, MOTOROLA mode

Operating conditions: CFGSPI = 0, INT_NMOT = 0

VDD = 3 ... 5.5V, Ta = -25 ... 85 °C; input levels lo = 0 ... 0.45 V, hi = 2.4 V ... VDD

Item	Symbol	Parameter	Conditions	Fig.			Unit
					Min.	Max.	
I20	tsAA	Setup Time: Address stable before ALE hi-lo		5/6	15		ns
I21	tAh	Signal Duration: ALE at high level		5/6	10		ns
I22	tsCA	Setup Time: NCS hi-lo until ALE hi-lo		5/6	10		ns
I23	thAA	Hold Time: Address stable after ALE hi-lo		5/6	15		ns
I24	tsAE	Setup Time: ALE hi-lo until NWR_E lo-hi		5/6	0		ns
I25	tsRE	Setup Time: NRD_RNW lo-hi until NWR_E lo-hi		5/6	0		ns
I26	tEh	Signal Duration: NWR_E at high level		5/6	10		ns
I27	tsDE	Setup Time: Data stable before NWR_E hi-lo		5	15		ns
I28	thED	Hold Time: Data stable before NWR_E hi-lo		5	0		ns
I29	thEC	Hold Time: NCS lo after NWR_E hi-lo		5/6	0		ns
I30	thER	Hold Time: NRD_RNW lo after NWR_E hi-lo		5/6	0		ns
I31	tpED1	Propagation Delay: Data stable after NWR_E lo-hi		6	0	25	ns
I32	tpED2	Propagation Delay: Data bus high impedance after NWR_E hi-lo		6	0	25	ns
I33	thEA	Hold Time: NWR_E hi-lo before ALE lo-hi	NCS = lo	5/6	0		ns

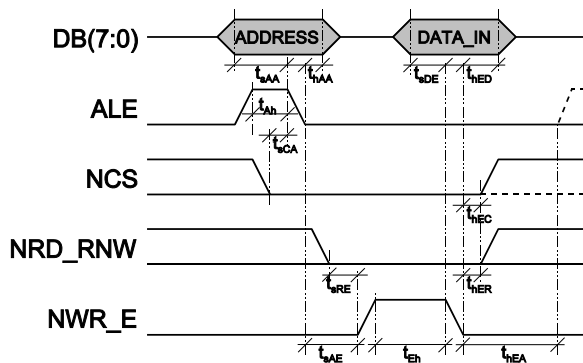

Figure 5: Write cycle (Motorola Mode)

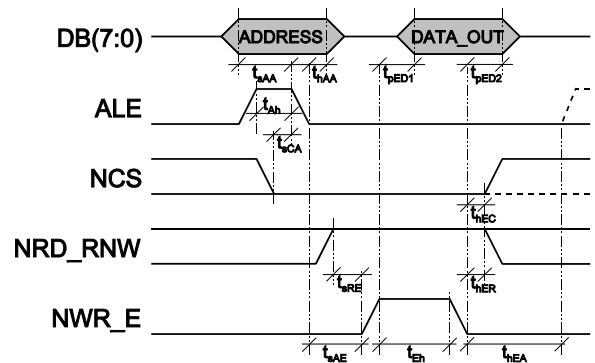

Figure 6: Read cycle (Motorola Mode)

OPERATING REQUIREMENTS: μ C Interface, SPI mode

Operating conditions: CFGSPI = 1

VDD = 3 ... 5.5V, Ta = -25 ... 85 °C; input levels lo = 0 ... 0.45 V, hi = 2.4 V ... VDD

Item	Symbol	Parameter	Conditions	Fig.	Timing		Unit
					Min.	Max.	
I40	t_{sCCL}	Setup Time: NCS hi-lo until SCLK/ALE lo-hi		0.29	10		ns
I41	t_{sDCL}	Setup Time: SI/DB0 stable before SCLK/ALE lo-hi		0.29	15		ns
I42	t_{hDCL}	Hold Time: SI/DB0 stable after SCLK/ALE lo-hi		0.29	0		ns
I43	t_{CLh}	Signal Duration SCLK/ALE hi		7a/b	10		ns
I44	t_{CLl}	Signal Duration SCLK/ALE lo		7a/b	10		ns
I45	t_{hCLC}	Hold Time: NCS lo after SCLK/ALE lo-hi		7a/b	0		ns
I46	t_{CSh}	Signal Duration NCS hi		7a/b	0		ns
I47	t_{pCLD}	Propagation Delay: SO/DB1 stable after SCLK/ALE hi-lo		7b	0	25	ns
I48	t_{pCSD}	Propagation Delay: SO/DB1 high impedance after NCS lo-hi		7b	0	25	ns

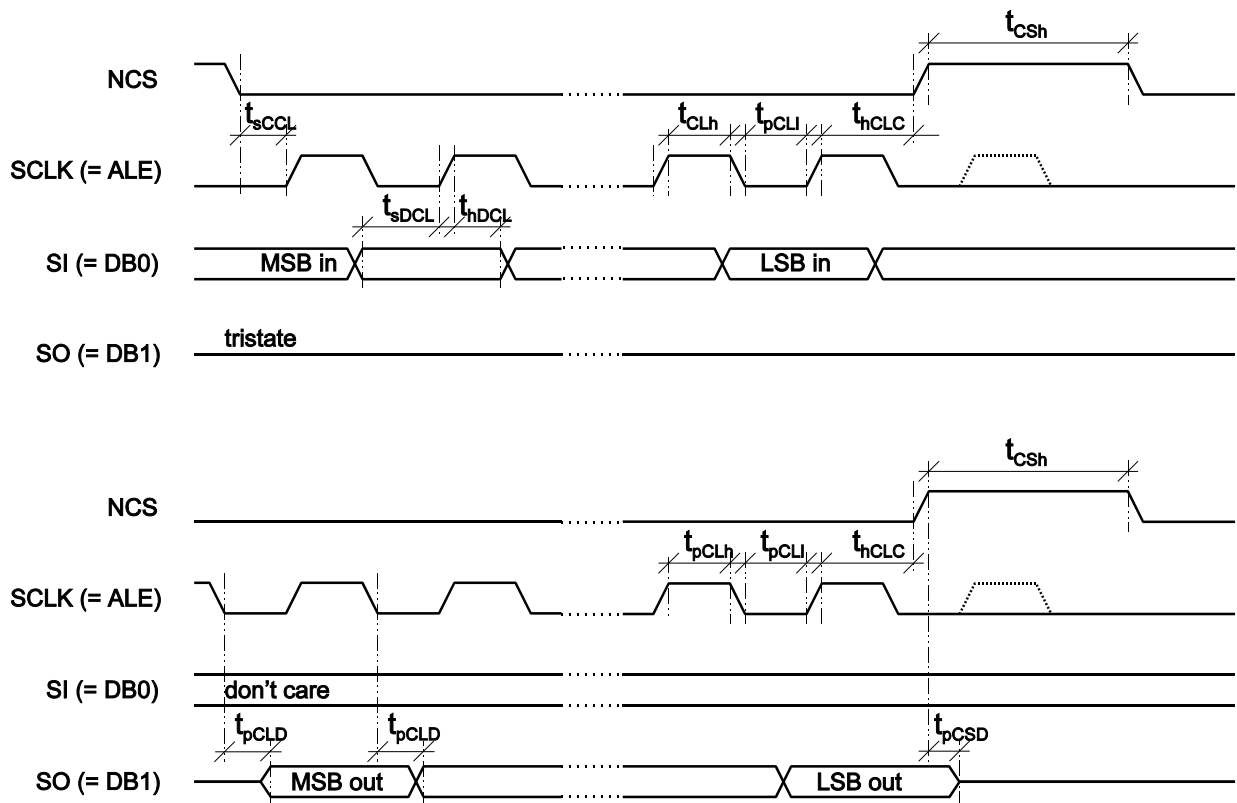

Figure 7: μ C interface in SPI mode with write cycle (top) and read cycles (bottom).

OPERATING REQUIREMENTS: BiSS Interface

Operating conditions: Register bit SELSSI = 0

VDD = 3 ... 5.5 V, Ta = -25 ... 85 °C; input levels lo = 0 ... 0.45 V, hi = 2.4 V ... VDD

Item	Symbol	Parameter	Conditions	Fig.			Unit
					Min.	Max.	
Sensor Mode							
I60	T _{MAS}	Clock Period	FreqSens via FREQ(4:0) selected in accordance with table on page 17	8	2	320	1/f(CLK)
I61	t _{MASl}	Clock Signal Lo Level Duration		8	50		% T _{MAS}
I62	t _{MASh}	Clock Signal Hi Level Duration		8	50		% T _{MAS}
I63	t _{pLine}	Permissible Line Delay		8	0	indefinite	
I64	Δt _{pL}	Permissible Propagation Delay of Subsequent Clock Cycles vs. 1 st Clock Cycle	Δt _{pL} = max(t _{pLine} - t _{pLx}); x= 1 ... n	8		25	% T _{MAS}
I65	T _{tos}	Permissible Timeout (Slave)		8	55		% T _{MAS}
Register Mode*							
I65	T _{MAR}	Clock Period	FreqReg via FREQ(7:5) selected in accordance with table on page 17	9	2	256	T _{MAS}
I66	t _{MA0h}	"Logic 0" Hi Level Duration		9	25		% T _{MAR}
I67	t _{MA1h}	"Logic 1" Hi Level Duration		9	75		% T _{MAR}
I68	t _{MAth}	Clock Signal Hi Level Duration	register data readout	9	50		% T _{MAR}
I69	t _{sSL}	Setup Time: SL1 stable before MA1 lo-hi		9	30		ns
I70	t _{hSL}	Hold Time: SL1 stable before MA1 lo-hi		9	20		ns
I71	T _{tor}	Permissible Timeout (Slave)		9	80		% T _{MAR}

*) For clocking to occur in register mode the slaves must have signaled that they are ready for register mode communication (see page 17).

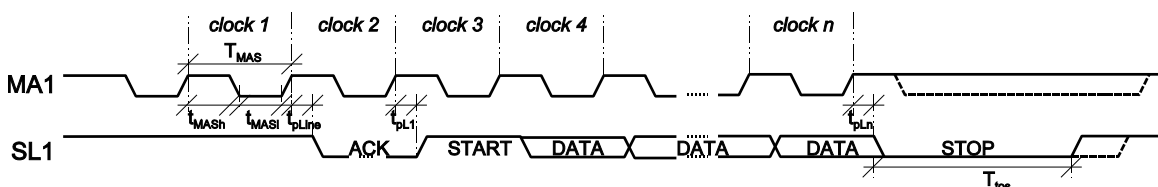

Figure 8: Timing diagram of sensor mode

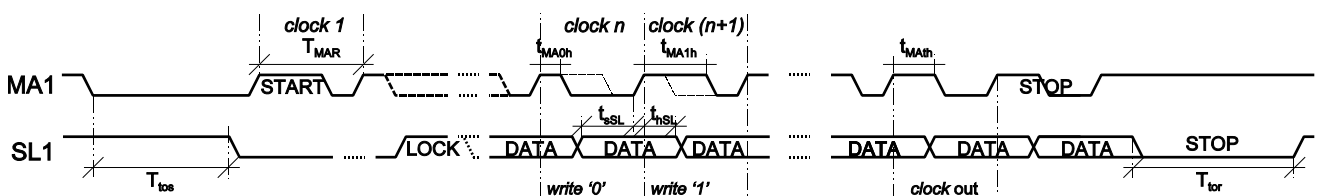

Figure 9: Timing diagram of register mode

Evaluating SL1 Signals

In BiSS mode delay times of longer than one clock cycle are permissible, with the result that line delays during communication are negligible. Evaluation of the sensor response is delayed until the first falling edge at SL1 while at MA1 the clock signal continues to be output.

Within one MA1 clock cycle four equally distributed sampling instances are available. Following the falling edge at SL1, the slave's acknowledge signal, the SL1 level is evaluated two sampling instances on, close to the center of the transmitted bit.

OPERATING REQUIREMENTS: *BiSS Interface (SSI mode)*

Operating conditions: Register bit SELSSI = 1;

VDD = 3 ... 5.5 V, Ta = -25 ... 85 °C; input levels lo = 0 ... 0.45 V, hi = 2.4 V ... VDD

Item	Symbol	Parameter	Conditions	Fig.			Unit
					Min.	Max.	
I80	T _{MAS}	Clock Period	FreqSens über FREQ(4:0) selected in accordance with table on page 17	10	2	320	1/f(CLK)
I81	t _{MASh}	Clock Signal Hi Level Duration		10	50		%T _{MAS}
I82	t _{MASl}	Clock Signal Lo Level Duration		10	50		%T _{MAS}
I83	t _{sDC}	Setup Time: SL1 stable before MA1 lo→hi		10	30		ns
I83	t _{hDC}	Hold Time: SL1 stable before MA1 lo→hi		10	10		ns

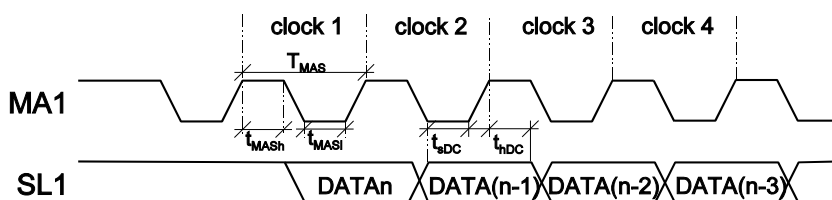

Figure 10: Timing diagram of SSI mode.

Evaluating SL1 Signals

In *BiSS* interface SSI mode SL1 values are sampled with the rising edge at MA1. An overall delay of the sensor response to the clock at MA1, caused by process times in the sensor or transmission times, is permissible up to the length of one clock cycle.

DESCRIPTION OF FUNCTIONS

iC-MB3 must be configured in accordance with the sensors connected to it; to this end a special area of memory has been included in the device. The other memory banks are used for the interim storage of incoming slave data or of slave data yet to be transmitted.

iC-MB3's second main component is its logic blocks which enable communication with the controller and generate the *BiSS* interface protocol on the slave side of the chip.

Microcontroller Interface

Via pins CFGSPI and INT_NMOT iC-MB3 can be configured for operation with an SPI-competent microcontroller, an Intel 8051 controller or a 68HC11 Motorola controller.

Here, 8-bit multiplex mode is used, in which the bidirectional data bus alternately transmits addresses and data in blocks of 8 bits (see Figures 3 to 6).

Communication Modes		
CFGSPI	INT_NMOT	Mode
0	0	Motorola 68HC11
0	1	Intel 8051
1	-	SPI (polarity= 0, phase= 0)

Intel mode

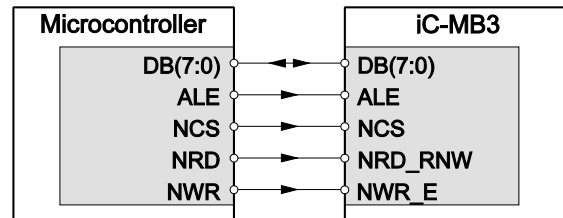

Motorola mode

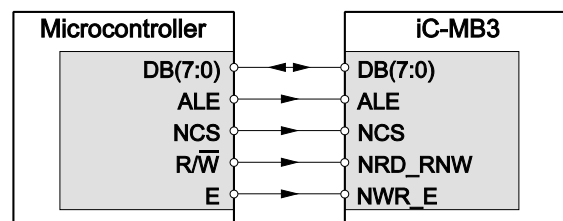

SPI mode

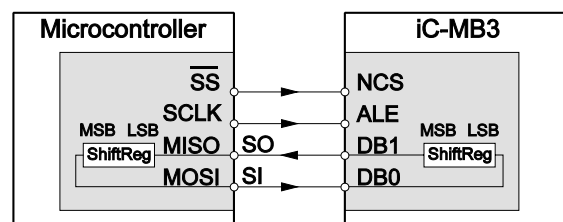

Figure 11: Wiring diagram for the microcontroller and iC-MB3.

When operated in conjunction with an SPI controller pin ALE is used as a clock input (SCK) and pin NCS as an enable input (NCS), with DB0 as the data input (SI) and DB1 as the data output (SO). Data is transmitted serially in successive blocks of 8 bits (command, address and data).

Four commands are available. These are WriteData (0000 0010b), ReadData (0000 0011b), ReadStatus (0000 0101b) and WriteInstruction (0000 0111b). The first two commands can be used to write data to or read data from iC-MB3's registers. The latter two commands are truncated write and read commands where the start address is fixed (namely that of the command register to address 244 and that of the status register to address 240). This means that it is not necessary to give an address, with the data directly adhering to the command.

With all commands it is possible to transmit several bytes of data consecutively if the NCS signal is not reset and ALE/SCK continues to be clocked. The address transmitted (240 for ReadStatus and 244 for WriteInstruction) is then the start address which is internally increased by 1 following each transmitted byte.

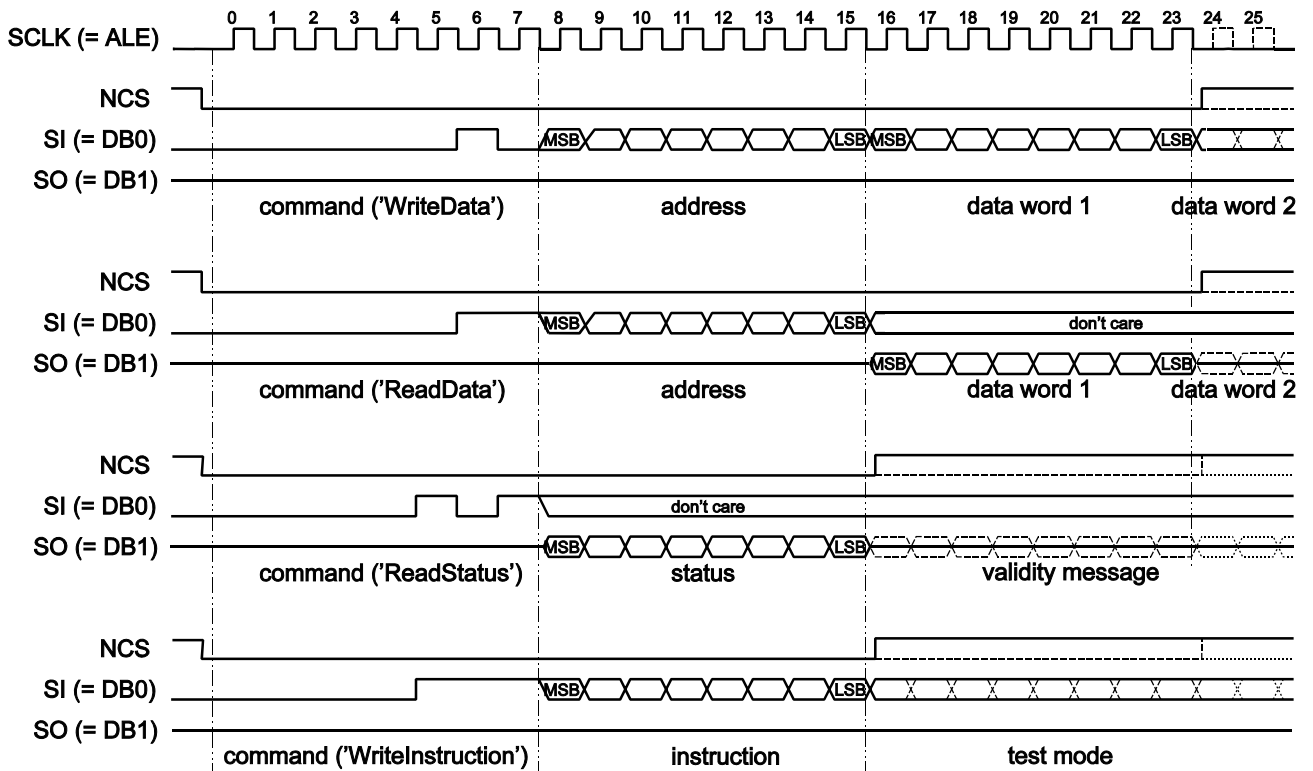

Figure 12: SPI transmission protocol (polarity 0, phase 0)

BiSS(SS) Interface Configurations

Device Registers					
Address ¹⁾	Description				Dir. ²⁾
00 ... 63	Sensor Data - 64 bits per Slave				in/out
	Slave 1 Addresses 07...00; lowest byte in Adr. 00	Slave 2 Addresses 15...08; lowest byte in Adr. 08	Slave 3 Addresses 23...16; lowest byte in Adr. 16	<i>Adr. 63...24 reserved for slaves 4...8</i>	
64 ... 127	reserved				
128 ... 191	159 ... 128: Register Data (32 bytes) <i>191 ... 160: reserved for additional register data</i>				bidir
192 ... 223	Slave Configuration Data - 32 bits per Slave				in
	Slave 1 Addresses 195...192	Slave 2 Addresses 199...196	Slave 3 Addresses 203...200	<i>Adr. 223...204 reserved for slaves 4...8</i>	
224 ... 229	Configuration of Register Communication				in
230 ... 239	Configuration of Master				in
240 ... 255	Status information and command register				in/out

¹⁾ All addresses are decimals unless otherwise stated.

²⁾ Direction in: Can only be written to by the μ C
 out: Can be read out only by the μ C
 in/out: Sections can be written to by the μ C in part and only be read out in part
 bidir: Can be written to and read out by the μ C

Reserved address range for other master devices.

Sensor Data, Multicycle Data and Slave Configuration											
Address			Description								
SL1	SL2	SL3									
07	15	23	Sensor Data - SDATA(63...0)								
...									
00	08	16									
			Configuration	Bit 7	Bit 6	Bit 5	Bit 4	Bit 3	Bit 2	Bit 1	Bit 0
192	196	200	Sensor Data	ACTnSENS	ENSENS	SDLEN(5:0)					
193	197	201	Sensor CRC	INVCRC	SENSCRCPOLY(7:1)						
194	198	202	Data Conversion	0x00, GRAY= 0: no conversion, for incoming data in binary format 0x80, GRAY= 1: Gray-to-binary conversion, for incoming data in Gray code							
195	199	203	reserved	0x00							

Key to the configuration bits:

- ACTnSENS Access to slave data: Read (0), Write (1)
- ENSENS: Adaptation to slave sensor data: available (1), not available (0)
- SDLEN: Bit length of sensor data ¹⁾
- INVCRC: Transmission of CRC bits for sensor data: inverted (1), not inverted (0)
- SENSCRCPOLY: CRC polynomial for verification of sensor data ²⁾

- GRAY Gray/binary data conversion of sensor (required for SSI encoders)

¹⁾ The length of the data should be given minus 1, i.e. for 64 data bits enter 63.

²⁾ If 0000 0000b is entered as the CRC polynomial, no cyclic redundancy check is carried out. As the last bit of a CRC polynomial is always 1 this is not entered in the polynomial register but added in the master. A CRC polynomial of up to 8 bits is thus possible. Should the full polynomial length not be required, the polynomial (minus its final 1) must be justified right and the spaces before it filled with zeros. For example, CRC polynomial 10 0011b is stored as 001 0001b.

Configuration Register Communication									
Address	Description	Bit 7	Bit 6	Bit 5	Bit 4	Bit 3	Bit 2	Bit 1	Bit 0
224	Not used	-	-	-	-	-	-	-	-
225	Not used	-	-	-	-	-	-	-	-
226	Start Address	WNR	REGADR(6:0)						
227	Count Of Bytes	-	-	REGNUM(5)	REGNUM(4:0)				
228	Channel Select	CHSEL(8:1)							
229	SlaveID	-	REGVERS	SLAVEID(2:0)			-	-	-

Configuration Master									
Address	Description	Bit 7	Bit 6	Bit 5	Bit 4	Bit 3	Bit 2	Bit 1	Bit 0
230	Frequency Division	FREQ(7:0)							
231	Not used	-	-	-	-	-	-	-	-
232	Frequency Division AutoGetsens	FREQAGS(7:0)							
233	Not used	-	-	-	-	-	-	-	-
Device ID									
234	Revision	0	0	0	0	0	0	1	0
235	Type	1000 0011b							
Configuration Channel									
236	Slave Location	SLAVELOC(8:1)							
237	Mode of Operation	SELSSI4	BiSSMOD4	SELSSI3	BiSSMOD3	SELSSI2	BiSSMOD2	SELSSI1	BiSSMOD1
238	Mode of Operation	SELSSI8	BiSSMOD8	SELSSI7	BiSSMOD7	SELSSI6	BiSSMOD6	SELSSI5	BiSSMOD5
239	Not used	-	-	-	-	-	-	-	-

Key to the configuration bits:

- SELSSI: Type of protocol: BiSS (0), SSI (1)
- BiSSMOD: BiSS protocol model: BiSS model A or B (0), BiSS-A/S (1)

Status Information and Command Register									
Address	Description	Bit 7	Bit 6	Bit 5	Bit 4	Bit 3	Bit 2	Bit 1	Bit 0
240	Status Information	nERR	nWDERR	d	nSENSERR	nREGERR	REGEND	d	EOT
241	Validity Messages ^{1,2)}	SVALID4	d	SVALID3	d	SVALID2	d	SVALID1	d
242	Validity Messages ^{1,2)}	SVALID8	d	SVALID7	d	SVALID6	d	SVALID5	d
243	Register Messages	CDM TIMEOUT	REG ^{2,4)}	REG-BYTES(5)	REGBYTES(4:0)				
244	Command Register	BREAK	UCREAD-SENS	SWRAM-BANK	INIT	REGCMD	GETSENS0	GETSENS1	AGS
245	Control Flages	MAv0	MAf0	MAvS	MAfS	reserved	IDDQ ³⁾	IFTEST ³⁾	CLKENI
246	Not used	-	-	-	-	-	-	-	-
247	Not used	-	-	-	-	-	-	-	-
248	Channel Status	REG4	SL4	REG3	SL3	REG2	SL2	REG1	SL1
249	Channel Status	REG8	SL8	REG7	SL7	REG6	SL6	REG5	SL5
250...255	Not used	-	-	-	-	-	-	-	-

 Reserved addresses for master devices featuring a higher slave or channel count, or more memory for register data.

1) Any attempt to write to this register sets register values to 0.

2) Two memory banks available.

3) iC-Haus device test only, set to 0.

4) For iC-MB3 the register bit REG is equal to REG1.

d Bit not relevant (don't care).

Configuration - Master

Master Clock

The master clock, either generated by the basic clock of the internal 20 MHz oscillator (CLKENI = 1) or by an external clock oscillator (CLKENI = 0) which supplies pin CLK, is set with the aid of the frequency division register (address 230).

The clock frequency for both BiSS sensor and SSI modes is set via FREQ(4:0) in accordance with the table on the top right. With an external clock pulse of $f_{CLK} = 20$ MHz clock frequencies ranging from 62.5 kHz to 10 MHz can thus be selected for sensor data transmission.

Both BiSS and SSI devices recognize an idle bus at the end of a transmission cycle via a monoflop timeout elapsing (timeoutSENS, see BiSS protocol). The choice of possible clock frequency is thus limited as the duration of both the high and low level may not exceed the shortest timeout of all of the connected subscribers (slaves).

BiSS devices switch to register mode on recognizing that the bus is idle after a high-low transition at the clock input and signal this state back to the master on the data line.

The clock frequency in BiSS register mode is set via FREQ(7:5) and can lie within a range of ca. 244 Hz to 5 MHz. Here selection is also limited as with the above; a different monoflop timeout now recognizes the idle bus at the end of the cycle (timeoutREG, see BiSS protocol).

Additionally, BiSS devices generally only permit a lower clock frequency (such as 250 kHz maximum, for example) because the clock form has to be evaluated as a PWM signal.

Automatic request for sensor data

The frequency with which new requests for sensor data are sent to the slaves is set using FREQAGS according to the table on the right. With an external clock of 20 MHz sensor data request cycles ranging from 1 μ s to 4 ms are possible.

FREQAGS must be set in such a way that the distance between two requests for data is greater than a complete cycle; this consists of the transmission of a request, an acknowledge signal (including any line delays), a start bit (including process times), a register bit (optional), the sensor and CRC bits of each slave and the longest sensor timeout of all the slaves.

Master Clock for BiSS Sensor Mode and SSI (FreqSens)

FREQ(3:0)	FREQ(4) = 0	FREQ(4) = 1
0	$f_{CLK}/2$	not permitted
1	$f_{CLK}/4$	$f_{CLK}/40$
2	$f_{CLK}/6$	$f_{CLK}/60$
3	$f_{CLK}/8$	$f_{CLK}/80$
4	$f_{CLK}/10$	$f_{CLK}/100$
5	$f_{CLK}/12$	$f_{CLK}/120$
6	$f_{CLK}/14$	$f_{CLK}/140$
7	$f_{CLK}/16$	$f_{CLK}/160$
8	$f_{CLK}/18$	$f_{CLK}/180$
9	$f_{CLK}/20$	$f_{CLK}/200$
10	$f_{CLK}/22$	$f_{CLK}/220$
11	$f_{CLK}/24$	$f_{CLK}/240$
12	$f_{CLK}/26$	$f_{CLK}/260$
13	$f_{CLK}/28$	$f_{CLK}/280$
14	$f_{CLK}/30$	$f_{CLK}/300$
15	$f_{CLK}/32$	$f_{CLK}/320$

A combination of FREQ(4) = 1 and FREQ(3:0) = 0 is not permitted; for a clock frequency of $f_{CLK}/20$ FREQ(4) = 0 and FREQ(3:0) = 9 must be set.

Master Clock for BiSS Register Mode (FreqReg)

FREQ(7:5)	FreqReg
0	FreqSens/2
1	FreqSens/4
2	FreqSens/8
3	FreqSens/16
4	FreqSens/32
5	FreqSens/64
6	FreqSens/128
7	FreqSens/256

Automatic Sensor Data Request (FreqAGS)

FREQAGS(6:0)	FREQAGS(7)= 0	FREQAGS(7)= 1
0	$f_{CLK}/20$	$f_{CLK}/625$
1	$f_{CLK}/40$	$f_{CLK}/1250$
2	$f_{CLK}/60$	$f_{CLK}/1875$
...
125	$f_{CLK}/2520$	$f_{CLK}/78750$
126	$f_{CLK}/2540$	$f_{CLK}/79375$
127	$f_{CLK}/2560$	$f_{CLK}/80000$

DATA STORAGE - Sensor Data

So that new sensor data can be read in during controller accesses iC-MB3 has dual memory banks for sensor data. While sensor data is being read into the first RAM, from the second RAM section the controller can read out the sensor data last read in. The relevant sensor data memory banks are swapped over at the end of the readin procedure; this can be prevented by the controller entering the command register bit UCREADSENS. In parallel with this the validity message register (address 241) and bit REG(address 248) are also swapped.

Arrangement of sensor data in the RAM

The sensor data memory bank has 8 bytes of memory for each slave which can be interpreted as 64 bits of memory in the array xxxxx111b to xxxxx000b. The sensor data is written to memory area [SDLEN - 1:0] with SDLEN marking the length of the relevant data. Should there be room in the available memory for the CRC bits, these are then also stored with the above data at positions [63:63 - (CRCLen-1)].

Example Slave 2: 20 bits of sensor data, 6 bits of CRC => total length of 26 bits

Adr. 07 ... 00: Sensor data Slave 1
Adr. 15 ... 08: Sensor data Slave 2 -
 Adr. 15: SensCRC(5:0), *not defined, not defined*
 Adr. 14: - *not defined* -
 Adr. 13: - *not defined* -
 Adr. 12: - *not defined* -
 Adr. 11: - *not defined* -
 Adr. 10: *not defined, not defined, not defined, not defined*, SensData(19:16)
 Adr. 9: SensData(15:8)
 Adr. 8: SensData(7:0)
Adr. 23 ... 16: Sensor data Slave 3
...

DATA STORAGE - register data

For the interim storage of register information read out from or to be written to the slaves iC-MB3 has an individual storage area (addresses 128 to 159) which can temporarily store up to 32 bytes of data. With just one single command this is then transmitted to a slave selected using SLAVEID(2:0) or requested from it as register data. The transmission of register data takes longer than that of sensor data so that the content of the sensor data RAM is then often obsolete.

STATUS INFORMATION and COMMAND REGISTER

Address 240: Status Messages			
Bit	Designation	Function	Remarks
7	nERR	An error has occurred (low active), equivalent to the pin level at NER (see "Error messaging" on page 22)	
6	nWDERR	Watchdog error (low active) on - transmissions triggered by an automatic sensor data request - transmissions of register data	1
5	reserved		4
4	nSENSERR	CRC error in the sensor data (low active)	2
3	nREGERR	CRC error during the transmission of register data (low active)	3
2	REGEND	End of register data transmission	
1	reserved		4
0	EOT	End of transmission: signals the end of sensor or register data transmission before timed out	

1. A watchdog error is triggered during the automatic transmission of sensor data if no new cycle could be initiated; bit AGS in the command register is reset and the automatic request for sensor data aborted. During the transmission of register data a watchdog error is triggered if the slave shows no response, i.e. if it does not answer the first falling master edge with a low or fails to generate a start bit.
2. If a sensor data error is signaled the faulty sensor can be verified by reading out address 241 (validity message).
3. If a register data error is generated the number of bytes transmitted correctly before the error occurred can be determined by reading out the register message REGBYTES (address 243, bits 5...0). In the event of error the transmission of data is terminated.
4. Bit is not relevant (don't care).

Address 241: Validity Messages			
Bit	Designation	Function	Remarks
7	reserved	Not used	1
6	SVALID4	Not used	1
5	reserved	Not used	1
4	SVALID3	Readout sensor data from slave 3 valid	1
3	reserved	Not used	1
2	SVALID2	Readout sensor data from slave 2 valid	1
1	reserved	Not used	1
0	SVALID1	Readout sensor data from slave 1 valid	1

1. Any attempt to write to this register resets the validity messages.

Address 243: Register Messages			
Bit	Designation	Function	Remarks
7	CDM TIMEOUT	Control data timeout elapsed (1), not elapsed (0)	1
6	REG	Current register data bit at the slave operating on <i>BiSS</i> model C	2
5	REGBYTES(5)	Not used	
4...0	REGBYTES(4:0)	Number of register bytes transmitted correctly if an error occurs	3

1. A new control data communication can only be made once the CDM timeout has elapsed; a new CDM data frame may not be introduced before this time.
2. During the data transmission in *BiSS* C-Mode protocol, where register data is transmitted together with the sensor data, the current register data bit can be read out via bit REG. Similar to the sensor data this bit also has a second storage section which allows the readout of bits transmitted during the last cycle while a new cycle is running. A swap occurs in parallel with that of the sensor data banks.
3. If no errors occur during transmission these bits are set to 0. Otherwise the number of register bytes successfully transmitted without error is displayed.

Address 244: Command Register			
Bit	Designation	Function	Remarks
7	BREAK	The current action is aborted (e.g. the clock at MA1 is stopped)	
6	UCREADSENS	RAM bank swapping is blocked	
5	SWRAMBANK	All RAM banks and the validity message register are forcibly swapped	
4	INIT	The sensor is initialized	
3	REGCMD	Executes transmissions of register data	
2	GETSENS0	Single request for sensor data with a high cycle termination (control data bit CDM = 0)	
1	GETSENS1	Single request for sensor data with a low cycle termination (control data bit CDM = 1)	
0	AGS	Start of automatic sensor data requests (AutoGetSens)	

All bits with the exception of AGS, UCREADSENS and SWRAMBANK are independently deleted by the master once the command has been carried out.

All current actions can be aborted using the BREAK command so that a defined state can be resumed if one of the sensors proves faulty, for example.

During the readout of more than one sensor data register by the controller it is possible that the RAM banks in the master could be swapped over once a sensor data transmission is complete. So that the controller only reads related values bit UCREADSENS should be set at the start of the readout and returned at the end; this suppresses the RAM swap. With the start of a new sensor data cycle previous values are then overwritten by the new sensor data.

Each setting or deletion of bit SWRAMBANK forces the sensor data banks to be swapped over. Data just input, for example, can then be read out if a cycle has ended during UCREADSENS = 1 (this is indicated by EOT in the status register switching to 1 during the suppression of the RAM swap).

The sensor chain can be initiated using the command INIT. A set REG bit starts the transmission of register data between iC-MB3 and a sensor.

The transmission of sensor data can be triggered via bits GETSENS0 and GETSENS1. In both instances a new transmission process is initiated; the difference between the two commands lies in how the transmission cycle is ended. With GETSENS0 the cycle finishes with a high; GETSENS1 ends on a low.

When initializing the sensor data transmission via GETSENS0 = 1 and GETSENS1 = 1, the cycle finishes with a level determined by the REG bit entered (Address 243, bit 6), i.e. for REG = 0 with a high or for REG = 1 with a low. By this function register data can be transmitted to slaves operating on the BiSS protocol model C principle in parallel to the transmission of sensor data (see "Transmission of register data in sensor mode").

If an AGS bit has been set sensor data is read in cyclically according to the cycle frequency set in register 232 (FREQAGS) without any further commands being issued by the controller.

Registers start address (REGADR, address 226), number of bytes (REGNUM, address 227) and slave ID (SLAVEID, address 229) stipulate from which slave register address onwards how many bytes are to be written to or read out from which specific slave. A byte count of 0 entered for REGNUM signals the transmission of a single register value; a 31 indicates the transmission of 32 register values. In the register REGBYTES (address 243) a 0 is entered if communication has proved error free. In the event of error the number of registers correctly read or written is displayed.

iC-MB3 does not support autonomous register communication as with BiSS C.Mode protocol, thus it is imperative that address 229's bit REGVERS remain set to 0.

Initialization (for slaves with BiSS B-Mode register communication)

To initialize the bus subscribers and to allow them to find their position in the queue (and particularly so that the first slave recognizes its position as such) the master line must be set to 0 after a 1 period (longer than the longest sensor timeout). The slaves themselves signal that initialization has been successful with a 0 on line SL1.

During initialization internal counters and error flags in the master are deleted or set as appropriate. Should a slave prove faulty and not switch to 0 initialization must be aborted by a BREAK command. Initialization ends when the CDM timeout flag is set (address 243).

Communication in sensor mode

The transmission of sensor data begins when at pin MA1 the master outputs the clock signal with the clock frequency selected by **FREQ**. The line delay, i.e. the transmission propagation until an acknowledgement is generated at SL1, is determined from the second falling edge onwards.

While the clock continues to be output at MA1 the master waits for the slaves' start bit (1) signaling the start of data transmission. Following this the actual clocking out of sensor data begins, i.e. the sensors place a new bit on the SL1 line with each rising edge on the MA1 line.

The sensor data being input into the master and the ensuing sets of CRC data are written to the appropriate sensor data RAM. At the same time the new CRC value is calculated in accordance with **InvSensCRC** and using the CRC polynomial stored in the configuration RAM. Should, after entry of the last CRC bit, the system ascertain that transmission was faulty the relevant validity message in address 241 is deleted and error message **nSENSERR** set in the status register at address 240. At the same time the sensor data RAM banks are swapped.

Register communication in BiSS B-Mode

Once the slaves have signaled their readiness for register communication (SL1 = 0) the addressing sequence is compiled, consisting of a start bit (1), the slave ID, the register address, the write/read flag, the inverted CRC calculated from this and a stop bit (0). This sequence is then transmitted bit by bit.

At the same time the ID distribution among the slaves is checked; should none of the slaves react (should SL1 not signal a 1 after 9 clock pulses) communication is aborted and a register error message generated (**nREGERR** = 0). The same happens if the slave response is not 0 after the 17th rising edge at MA1.

If a register value is to be transmitted to a slave transmission of the new register value begins after 17 clock pulses (i.e. following the transmission of the start bit, slave ID, register address, **WNR**, CRC and stop bit). This new register value consists of a start bit (1), the new contents of the register, the inverted CRC code and a stop bit (0). At the same time the slave response (SL1) is checked. If the slave does not send a start bit for any reason (if the register addressed does not exist, for example, or access to a write protected register is attempted) communication is aborted after 4,096 MA1 clock pulses and the message **nWDERR** generated; a register error (**nREGERR** = 0) is signaled if the CRC proves faulty.

If transmission has proved free of error further register values are then compiled as needed and transmitted until communication with the register has ended. If no errors have occurred during communication register 243 then has a value of 0; in the event of error this value is the number of bytes transmitted correctly.

When reading out a register value from a slave, following a correct addressing sequence (see above) the system waits while the clock pulse continues to be output at MA1 until the addressed slave sends a start bit. During this waiting period a slave can read out a connected EEPROM, for example, and then transmit this value to the master. Once the slave's start bit has been entered into the master the actual data bits are stored and the CRC carried out on the fly. This cyclic redundancy check operates with the fixed polynomial 10011b and with inverted CRC bits. Should a CRC error occur during transmission this is signaled by a register error; the number of register values transmitted without error is stored in register 243 and further communication aborted.

If no errors occur during the transmission of data the next register values can be transmitted from the slave to the master by continued clock pulses at MA1. Register 243 contains a 0 if transmission has proved error free.

At the end of communication in register mode the CDM timeout flag is set (address 243).

Error messaging

In sensor mode the validity of data is stored separately for each slave in the validity message register (address 241). In the event of error the appropriate validity message is deleted and nSENSERR set to 0 in the status register. The error is signaled at pin NER.

In register mode a register error (nREGERR = 0) or a slave start signal missed for at least 4,096 MA1 clock pulses results in an error message at NER. As following initialization no valid sensor data yet exists all the bits in the validity message (address 241) are deleted; no display is generated at pin NER, however.

A watchdog error is triggered if during the automatic sensor data requests no new readout cycle was able to be initiated. In this instance bit AGS is reset in the command register and the cyclic sensor data requests aborted.

A watchdog error is also triggered if a slave response is lacking during the transmission of register data. This has two possible causes; either a slave does not respond to the first falling edge with a low or the slave fails to generate a start bit.

It is possible to connect other components to pin NER which can also generate an error message; this can then be read out via bit nERR in the status register at address 240.

Register communication in sensor mode (BiSS C-Mode)

In the BiSS C-Mode protocol it is possible to send register data to or receive register data from a slave during the cyclic sensor data transmission. In conjunction with iC-MB3 the microcontroller must take care of control data communications, and has to employ GETSENS0 and GETSENS1 to transmit the required CDM data.

For register data transmission in the opposite direction, from a sensor to the BiSS master, an additional bit is introduced and filled in by the responding slave before the sensor data. So that the first data bit received is treated as CDS, BiSSMOD1 must be set to 1 (address 237).

APPLICATION HINTS

Example system: iC-MB3 with two interpolators iC-NQ

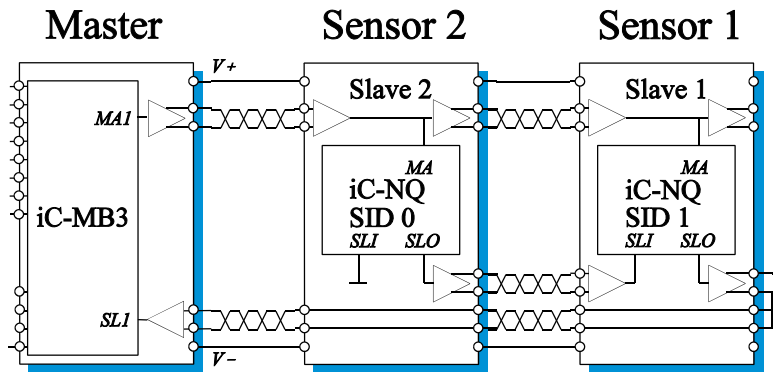

Figure 13: Example configuration

Sensor1: <Manufacturer Code="6943"> – iC-Haus <Device Code="4E5159300300"> – iC-NQ RES=8192 <Sens> <Length>15</Length> – 13 bits sensor data + error1 + error2 <CrcPoly>0x25</CrcPoly> – polynomial '01001011'b <InvCrc>1</InvCrc> – CRC bits inverted </Sens> <Reg> <IdUsed>1</IdUsed> – 128 register max. => single slave ID </Reg> </Device> </Manufacturer>	Sensor2: <Manufacturer Code="6943"> – iC-Haus <Device Code="4E5159302600"> – iC-NQ RES=1024, period counter <Sens> <Length>20</Length> – 8 bits period counter, 10 bits sensor data+ error1 + error2 <CrcPoly>0x25</CrcPoly> – polynomial '01001011'b <InvCrc>1</InvCrc> – CRC bits inverted </Sens> <Reg> <IdUsed>1</IdUsed> – 128 register max. => single slave ID </Reg> </Device> </Manufacturer>
--	--

Figure 14: Example BiSS device description file in XML

Assumptions:

Sensor 1: iC-NQ with angle resolution 8,192:
 13 bit angle data, 2 error bits, CRC polynomial 10 0101b and inverted output,
 Timeout_{SENS}: 2,62 µs

Sensor 2: iC-NQ with angle resolution 1,024 and period counting:
 8 bit period counter data plus 10 bit angle data, 2 error bits,
 CRC polynomial 10 0101b and an inverted output;
 Timeout_{SENS}: 2,62 µs

iC-MB3 clock: 20 MHz (according to the electrical characteristics in the data sheet)

Setting the master clock for sensor mode: max. 10 MHz => FREQ(4:0) = 00000b (10 MHz)

Setting the master clock for register mode: max. 250 kHz => FREQ(7:5) = 101b (156 kHz)

Setting the cycle time for the automatic sensor data request:

without transmission delays and processing times =>

$$\text{cycle time} = (3 + (15+6+1) + (20+6+1)) \text{ clock pulses} + \text{Timeout}_{\text{SENS}}$$

$$= 52 * 0,1\mu\text{s} + 2,62\mu\text{s} = 7,82\mu\text{s} \approx 156 * t_{\text{CLK}}$$

AutoGetSens time > cycle time => FREQAGS ≥ 7

iC-MB3

BiSS INTERFACE MASTER, 1-Chan./3-Slaves



Rev D1, Page 25/26

Example system: Required configurations of iC-MB3

Configuration Master									
Address	Description	Bit 7	Bit 6	Bit 5	Bit 4	Bit 3	Bit 2	Bit 1	Bit 0
230	Frequency Division					1010	0000b		
232	Frequency Division AutoGetsens					0000	0111b		

Slave Configuration: Slave 1									
Address	Description	Bit 7	Bit 6	Bit 5	Bit 4	Bit 3	Bit 2	Bit 1	Bit 0
192	Sensor data	0	1			00	1110b		
193	Sensor-CRC	1				001	0010b		
194	Data Conversion	0x00							
195	reserved	0x00							

Slave Configuration: Slave 2									
Address	Description	Bit 7	Bit 6	Bit 5	Bit 4	Bit 3	Bit 2	Bit 1	Bit 0
196	Sensor data	0	1			01	0011b		
197	Sensor-CRC	1				001	0010b		
198	Data Conversion	0x00							
199	reserved	0x00							

Slave Configuration: Slave 3									
Address	Description	Bit 7	Bit 6	Bit 5	Bit 4	Bit 3	Bit 2	Bit 1	Bit 0
200	Sensor data	0	0						
201	Sensor-CRC								
202	Data Conversion	0x00							
203	reserved	0x00							

This specification is for a newly developed product. iC-Haus therefore reserves the right to change or update, without notice, any information contained herein, design and specification; and to discontinue or limit production or distribution of any product versions. Please contact iC-Haus to ascertain the current data. Copying -- even as an excerpt -- is only permitted with iC-Haus approval in writing and precise reference to source.

iC-Haus does not warrant the accuracy, completeness or timeliness of the specification on this site and does not assume liability for any errors or omissions in the materials. The data specified is intended solely for the purpose of product description. No representations or warranties, either express or implied, of merchantability, fitness for a particular purpose or of any other nature are made hereunder with respect to information/specification or the products to which information refers and no guarantee with respect to compliance to the intended use is given. In particular, this also applies to the stated possible applications or areas of applications of the product.

iC-Haus conveys no patent, copyright, mask work right or other trade mark right to this product. iC-Haus assumes no liability for any patent and/or other trade mark rights of a third party resulting from processing or handling of the product and/or any other use of the product.

As a general rule our developments, IPs, principle circuitry and range of Integrated Circuits are suitable and specifically designed for appropriate use in technical applications, such as in devices, systems and any kind of technical equipment, in so far as they do not infringe existing patent rights. In principle the range of use is limitless in a technical sense and refers to the products listed in the inventory of goods compiled for the 2008 and following export trade statistics issued annually by the Bureau of Statistics in Wiesbaden, for example, or to any product in the product catalogue published for the 2007 and following exhibitions in Hanover (Hannover-Messe).

We understand suitable application of our published designs to be state-of-the-art technology which can no longer be classed as inventive under the stipulations of patent law. Our explicit application notes are to be treated only as mere examples of the many possible and extremely advantageous uses our products can be put to.

iC-MB3

BiSS INTERFACE MASTER, 1-Chan./3-Slaves



Rev D1, Page 26/26

ORDERING INFORMATION

Type	Package	Order designation
iC-MB3	TSSOP24 4.4 mm	iC-MB3 TSSOP24
Demo Board SPI Demo Board PAR		iC-MB3 EVAL MB3D-S iC-MB3 EVAL MB3D-P
BiSS PC-LPT Adapter BiSS PC-USB Adapter		Please refer to descriptions available separately.

For technical support, information about prices and terms of delivery please contact:

iC-Haus GmbH
Am Kuemmerling 18
D-55294 Bodenheim
GERMANY

Tel +49-6135-9292-0
Fax +49-6135-9292-192
<http://www.ichaus.com>
E-mail sales@ichaus.com

Appointed local distributors: http://www.ichaus.de/support_distributors.php